

# 2019 CIF Boys State Championship Wrestling Tournament



## Placers

106 Lbs.			113 Lbs.			126 Lbs.			132 Lbs.			138 Lbs.			145 Lbs.		
1st	FIGUEROA, RICHARD (10) CS-1 #1	Selma (CS)	1st	LUJAN, TRISTAN (11) CS-1 #1	Selma (CS)	1st	NAGAO, AARON (11) SS-1 #1	Esperanza (SS)	1st	PARCO, KYLE (12) NC-1 #1	De La Salle (NC)	1st	VASQUEZ, JESSE (11) SS-1 #1	Excelsior Charter (SS)	1st	ABAS, JADEN (12) SD-1 #1	Rancho Bernardo (SD)
2nd	GIOFFRE, JACK (9) CS-2 #2	Buchanan (CS)	2nd	NEGRETE JR, CARLOS (10) CS-2 #2	Buchanan (CS)	2nd	NUNEZ, CHRISTAN (12) SS-2 #4	Bishop Amat (SS)	2nd	FRANCO, RYAN (10) CS-1 #2	Clovis North (CS)	2nd	SALDATE, CHASE (11) CC-1 #2	Gilroy (CC)	2nd	VALENCIA, CAEL (10) SS-1 #2	St. John Bosco (SS)
3rd	GONZALES, ANDRE (10) SD-1 #3	Poway (SD)	3rd	TUBERA, IZZY (11) SJ-1 #3	Pitman (SJ)	3rd	MIRANDA, JASON (11) SD-1 #3	Poway (SD)	3rd	PORTER, HENRY (10) SJ-1 #4	Oakdale (SJ)	3rd	MORPHIS, RYAN (12) CS-3 #9	Frontier (CS)	3rd	SIHAVONG, DAWSON (12) CS-1 #3	Bullard (CS)
4th	ABELL, BRAYDEN (10) SJ-3 #4	Oakdale (SJ)	4th	MOURITSEN, JUSTIN (11) CS-3 #7	Clovis (CS)	4th	LORENZO, ANTONIO (12) SS-1 #5	St. John Bosco (SS)	4th	PETRUCCELLI, GIANO (10) CS-2 #8	Clovis (CS)	4th	LE, JADEN (11) SD-1 #8	Rancho Bernardo (SD)	4th	MARTIN, JOSEPH (9) CS-2 #5	Buchanan (CS)
5th	ROMNEY, ZETH (9) SS-3 #8	Chaminade (SS)	5th	FREDRICKSON, BLAKE (12) NC-1 #8	Windsor (NC)	5th	CASTRO-SANDOVAL, RICHARD (11) SS-3 #11	Sultana (SS)	5th	FERNANDEZ III, JOSE (12) NC-2 #5	Upper Lake (NC)	5th	DEEN, TYLER (12) CS-1 #3	Buchanan (CS)	5th	WICK, LUKA (10) SS-2 #4	San Marino (SS)
6th	BARRETO, FERNANDO (9) SS-1 #6	Rowland (SS)	6th	CABUAG, CHRISTIAN (10) CC-1 #5	Vista Christian (CC)	6th	SPANGLER, RYAN (11) SS-3 #11	Sultana (SS)	6th	POLANCO, MARCOS (12) SS-1 #3	Bishop Amat (SS)	6th	ARROYO, LUCIANO (12) SS-2 #5	Calvary Chapel (SS)	6th	FOX, JOHN (12) CC-1 #6	Gilroy (CC)
7th	GARCIA, DEVIN (12) NC-1 #5	James Logan (NC)	7th	BIGLER, MICHAEL (11) CC-3	Archbishop Riordan (CC)	7th	REYES, COLE (12) CS-6 #6	Frontier (CS)	7th	MEDINA, JOSHUA (11) SS-3 #9	Servite (SS)	7th	BLAKE, ELI (11) SJ-3 #7	Del Oro (SJ)	7th	RAMSTHALER, JEFF (12) SD-2 #8	Ramona (SD)
8th	FUNAKOSHI, YOSHIYA (9) SS-4	West Torrance (SS)	8th	AHOLELEI, KAVIKA (12) SS-3 #13	Yorba Linda (SS)	8th	MENDOZA, KOREY (11) SS-9	Yucaipa (SS)	8th	JOHNSON, BRENDEN (11) SJ-3 #13	Del Oro (SJ)	8th	OKADA, TEDDY (12) SS-4 #11	Servite (SS)	8th	HANSEN, JACOB (12) SS-3 #7	Royal (SS)

152 Lbs.			160 Lbs.			170 Lbs.			182 Lbs.			195 Lbs.			220 Lbs.			285 Lbs.		
1st	SANTIAGO, SONNY (11) SS-2 #5	St. John Bosco (SS)	1st	OLGUIN, MATTHEW (12) CS-1 #1	Buchanan (CS)	1st	MUNOZ, TREY (12) SS-1 #1	Trabuco Hills (SS)	1st	HAAS, NATHAN (11) SS-1 #2	St. John Bosco (SS)	1st	REYES, RYAN (12) CC-1 #1	Gilroy (CC)	1st	GOOD, JACOB (12) CS-1 #2	Clovis (CS)	1st	JEFFUS, MICHAEL (12) SJ-1 #2	Turlock (SJ)
2nd	BADGETT, TYLER (11) SD-2 #6	Rancho Bernardo (SD)	2nd	BLAKE, NOAH (12) SJ-1 #2	Del Oro (SJ)	2nd	CONTINO, ROCCO (10) CS-3 #6	Buchanan (CS)	2nd	SMITH, JONOVAN (12) LA-1 #4	Birmingham (LA)	2nd	MARTIN, JADON (11) CS-1 #3	Buchanan (CS)	2nd	RUIZ, MIKE (12) SS-3 #5	Villa Park (SS)	2nd	VILLARREAL, NICHOLAS (11) CC-1 #1	Gilroy (CC)
3rd	LUCHAU, JACE (12) CS-1 #1	Selma (CS)	3rd	WILNER, MAX (10) SS-1 #4	Fountain Valley (SS)	3rd	COSIO, RYAN (12) SS-2 #4	Temecula Valley (SS)	3rd	TRACY, TRENT (12) CS-1 #1	Frontier (CS)	3rd	GOULD, BEN (12) SS-1 #6	Valencia/Valencia (SS)	3rd	ESCOBEDO, GUILLERMO (11) SS-1 #4	Bishop Amat (SS)	3rd	RAMOS, JUSTIN (12) SJ-2 #3	Vista del Lago (SJ)
4th	GANDARA, AARON (11) SD-1 #2	Poway (SD)	4th	AGUIRRE, MAX (12) CS-2 #3	Frontier (CS)	4th	LONG, DANIEL (12) CS-6 #5	Dinuba (CS)	4th	KILNER, JACK (12) NC-1 #6	Granada (NC)	4th	DAHLE, REAGAN (12) NS-1 #15	Big Valley (NS)	4th	DARTER, JUSTIN (10) CS-2 #8	Bakersfield (CS)	4th	MARKEY, LEVI (12) SJ-5 #4	Del Campo (SJ)
5th	STINSON, JT (11) NS-1 #3	East Nicolaus (NS)	5th	ZAVALA, NICHOLAS (11) CS-3 #9	Mission Oak (CS)	5th	RODRIGUEZ, CHRISTIAN (12) CS-1 #2	Selma (CS)	5th	GIANAKOPOULOS, TYLER (11) CS-2 #3	Clovis (CS)	5th	DAHLE, REAGAN (12) NS-1 #15	Big Valley (NS)	5th	CHRISTENSEN, JACOB (10) NS-1 #6	Durham (NS)	5th	FELICIANO, COHLE (12) CC-2 #5	Fremont (CC)
6th	VIZCARRA, DANIEL (12) CC-1 #8	Gilroy (CC)	6th	ROJAS, LOUIS (12) SS-2 #7	St. John Bosco (SS)	6th	CARDWELL, MARK (12) CS-2 #3	Monache (CS)	6th	CURTIS, JOE (11) SD-2 #8	La Costa Canyon (SD)	6th	MING, PETER (11) SJ-2 #5	Elk Grove (SJ)	6th	VON GOEBEN, WILLIAM (12) SS-3 #14	Walnut (SS)	6th	HILL, JOSIAH (11) CS-1 #7	Bakersfield (CS)
7th	DUCHARME, TYEE (12) SJ-1 #7	Vacaville (SJ)	7th	VILLARREAL, NATHAN (12) CC-1 #16	Gilroy (CC)	7th	PRIEST, JARAD (11) CS-4 #7	Bakersfield (CS)	7th	LEWIS, MALIK (12) SJ-1 #5	Franklin-EG (SJ)	7th	LEON, BRANDON (11) SS-4 #9	Roosevelt (SS)	7th	HILL, JOSIAH (11) CS-1 #7	Bakersfield (CS)			
8th	BUCK, VALOR (11) SS-3 #12	Servite (SS)	8th	KLOSTER, WILL (11) CS-4 #10	Lemoore (CS)	8th	MARTINEZ, GABRIEL (12) SJ-1 #8	Oakdale (SJ)	8th	JOVERO, JAVEN (10) SD-1 #7	Rancho Bernardo (SD)	8th	CHAVEZ, ADRIAN (12) NC-1 #2	Liberty (NC)	8th	SARTORIO, JACOB (12) NC-2	Clayton Valley (NC)			

Team Score - Final			SP	Fn	SC
5	1	Buchanan (CS)	8	6	235.0
6	2	Gilroy (CC)	7	3	182.0
1	3	Clovis (CS)	5	2	171.5
2	4	Selma (CS)	5	2	139.5
3	5	St. John Bosco (SS)	5	3	128.5
8	6	Poway (SD)	4	0	112.0
7	7	Frontier (CS)	4	0	99.5
12	8	Rancho Bernardo (SD)	4	2	91.0
9	9	Clovis North (CS)	2	1	90.5
1	10	Oakdale (SJ)	3	0	88.0
2	11	Servite (SS)	4	0	70.0
4	12	Bakersfield (CS)	3	0	66.5
3	13	Del Oro (SJ)	3	1	66.0
9	14	De La Salle (NC)	1	1	63.0
7	15	Bishop Amat (SS)	3	1	60.5
16	16	Esperanza (SS)	2	1	58.0
10	17	Vacaville (SJ)	1	0	57.0
18	18	Turlock (SJ)	1	1	45.0
1	19	Pitman (SJ)	1	0	40.0
6	20	Trabuco Hills (SS)	1	1	40.0
4	21	Temecula Valley (SS)	1	0	39.0
5	22	Chaminade (SS)	2	0	35.0
2	23	Excelsior Charter (SS)	1	1	34.0
3	24	San Marino (SS)	1	0	33.5
7	25	Calvary Chapel (SS)	1	0	33.5
8	26	Northview (SS)	0	0	32.5
27	27	Bullard (CS)	1	0	32.0
2	28	Villa Park (SS)	1	1	32.0
4	29	Fountain Valley (SS)	1	0	29.5
1	30	Lemoore (CS)	2	0	29.0
6	31	Valencia/Valencia (SS)	1	0	29.0
3	32	Franklin-EG (SJ)	1	0	28.0
8	33	Windsor (SD)	1	0	28.0
5	34	Vista del Lago (SJ)	1	0	27.0
7	35	Granada (NC)	1	0	25.5
36	36	Sultana (SS)	1	0	25.0
1	37	Big Valley (NS)	1	0	25.0
3	38	Birmingham (LA)	1	1	25.0
6	39	Dinuba (CS)	1	0	24.5
7	40	Elk Grove (SJ)	1	0	24.0
15	41	Clovis West (CS)	0	0	23.0
5	42	Santa Ynez (SS)	1	0	22.0
9	43	Folsom (SJ)	1	0	22.0
2	44	Kingsburg (CS)	0	0	21.0
1	45	Liberty (NC)	1	0	21.0
2	46	Monte Vista Christian (CC)	1	0	20.0
5	47	West Torrance (SS)	1	0	20.0
4	48	Sutter (NS)	0	0	19.0
8	49	Rowland (SS)	1	0	19.0
7	50	Fremont (CC)	1	0	19.0
6	51	Victor Valley (SS)	0	0	18.5
3	52	Walnut (SS)	1	0	18.0
16	53	James Logan (NC)	1	0	18.0
1	54	Mission Oak (CS)	1	0	18.0
2	55	Del Campo (SJ)	1	0	18.0
1	56	Yorba Linda (SS)	1	0	17.0
3	57	East Nicolaus (NS)	1	0	17.0
4	58	Exeter (CS)	0	0	16.0
5	59	Evergreen Valley (CC)	0	0	16.0
14	60	Upper Lake (NC)	1	0	16.0
7	61	Upper Lake (NC)	1	0	16.0

# CIF Boys State Championship

Weight Class : **106 Lbs.**



Weight Class	Participant	Score	Opponent	Score
106 Lbs.	FIGUEROA #1 SEL CS1	4.0	F 1:06	4.0
	449	7.0	FIGUEROA #1 SEL CS1	F 1:04
	ROMNEY #8 CHM SS3	2.0	11 4	2.0
	505	12.5	FIGUEROA #1 SEL	TF 15-0
	450	5.0	ABELL #4 OKD SJ3	3 0
	451	5.0	GONZALES #3 POW SD1	7 4
	452	7.0	GIOFFRE #2 BUC CS2	DEF
	506	12.0	GIOFFRE #2 BUC	13 3
106 Lbs.	FIGUEROA, RICHARD (10) CS-1 #1 Selma (CS)	5.5	1st	TF 18-3
	533	5.5	FIGUEROA #1 SEL	TF 18-3
	GIOFFRE, JACK (9) CS-2 #2 Buchanan (CS)	4.0	2nd	
	506	4.0	GIOFFRE #2 BUC	DEF
	451	4.0	GONZALES #3 POW SD1	3 2
	452	4.0	GIOFFRE #2 BUC CS2	DEF
	506	4.0	GIOFFRE #2 BUC	DEF
	506	4.0	GIOFFRE #2 BUC	DEF
106 Lbs.	1105	2.0	GONZALES POW	5 4
1107	1.0	GARCIA #5 JL	9 6	
1106	1.0	ROMNEY #1 CHM	DEF	

Participant	Score	Opponent	Score
FIGUEROA, RICHARD (10) CS-1 #1 Selma (CS)	5.5	1st	TF 18-3
GIOFFRE, JACK (9) CS-2 #2 Buchanan (CS)	4.0	2nd	
GONZALES, ANDRE (10) SD-1 #3 Poway (SD)	4.0	3rd	
ABELL, BRAYDEN (10) SJ-3 #4 Oakdale (SJ)	4.0	4th	
ROMNEY, ZETH (9) SS-3 #8 Chaminade (SS)	4.0	5th	
BARRETO, FERNANDO (9) SS-1 #6 Rowland (SS)	4.0	6th	
GARCIA, DEVIN (12) NC-1 #5 James Logan (NC)	4.0	7th	
FUNAKOSHI, YOSHIYA (9) SS-4 West Torrance (SS)	4.0	8th	

Participant	Score	Opponent	Score
FIGUEROA, RICHARD (10) CS-1 #1 Selma (CS)	5.5	1st	TF 18-3
GIOFFRE, JACK (9) CS-2 #2 Buchanan (CS)	4.0	2nd	
GONZALES, ANDRE (10) SD-1 #3 Poway (SD)	4.0	3rd	
ABELL, BRAYDEN (10) SJ-3 #4 Oakdale (SJ)	4.0	4th	
ROMNEY, ZETH (9) SS-3 #8 Chaminade (SS)	4.0	5th	
BARRETO, FERNANDO (9) SS-1 #6 Rowland (SS)	4.0	6th	
GARCIA, DEVIN (12) NC-1 #5 James Logan (NC)	4.0	7th	
FUNAKOSHI, YOSHIYA (9) SS-4 West Torrance (SS)	4.0	8th	



# CIF Boys State Championship

Weight Class : 113 Lbs.



SILVA, ANDREW (12) SS-2 #16	SILVA #16	SRV	8	4	4.0
Servite (SS)	129				
TAYLOR, EVAN (12) SJ-4	Folsom (SJ)				
345					
BIGLER, MICHAEL (11) CC-3	Archbishop Riordan (CC)				
LUJAN #1					
ROMAN, ROQUEE (12) LA-2	Birmingham (LA)				
9					
LUJAN, TRISTAN (11) CS-1 #1	Selma (CS)				
F 1:45					
BOBZIEN, BROCK (9) SD-1 #9	Poway (SD)				
131					
REYES, VINNY (11) SS-7	Redondo Union (SS)				
346					
JIMENEZ, OUT (9) CS-T	Redwood (CS)				
132					
CASTRO, JAVIER (11) CS-8	Dinuba (CS)				
10					
FREDRICKSON, BLAKE (12) NC-1 #8	Windsor (NC)				
F 1:57					
AHMED, IBRAHIM (9) SS-1 #12	Palm Desert (SS)				
133					
TORRES, MICHAEL (9) SJ-5	Oakdale (SJ)				
347					
CONCEPCION, GAVIN (11) SD-3	Rancho Bernardo (SD)				
134					
MADRIGAL, GIOVANI (12) CS-7	Madera (CS)				
11					
CABUAG, CHRISTIAN (10) CC-1 #5	Monte Vista Christian (CC)				
F .49					
AHOLELEI, KAVIKA (12) SS-3 #13	Yorba Linda (SS)				
135					
GARCIA, ROMAN (12) CS-6	El Diamante (CS)				
348					
OWENS, BLADE (12) SS-9	Apple Valley (SS)				
136					
SPINEL, NOAH (10) SF-1	Washington (SF)				
12					
HERYFORD, JIMMY (12) NS-1 #4	Sutter (NS)				
F .41					

## 113 Lbs.

TUBERA, IZZY (11) SJ-1 #3	Pitman (SJ)				
137					
CHAVEZ, MARTIN (12) CS-5	Orange Cove (CS)				
349					
ONSUREZ, ASHTON (10) CS-9	Bakersfield (CS)				
138					
MCNEAL #14					
6 2					
ALLRED, JUSTIN (12) SS-4	La Habra (SS)				
13					
MCNEAL, ROMEO (12) NC-2 #14	James Logan (NC)				
GIRON, WILLIAM (11) SJ-3 #11	Turlock (SJ)				
139					
THOMPSON, ZAK (10) CC-2	Palma (CC)				
350					
PARKER, ZACH (9) SS-5	Fountain Valley (SS)				
140					
LOERA, CRISTIAN (10) LA-1	San Fernando (LA)				
14					
ZINKIN, HAYDEN (9) CS-4 #6	Clovis North (CS)				
6 0					
ELLIOTT, DAMION (9) SJ-2 #10	Del Oro (SJ)				
141					
MALDONADO, TONY (11) SD-4	Brawley (SD)				
351					
RUIZ, KOA (9) SS-8	San Marino (SS)				
142					
MOURITSEN #7					
4 2					
STROLE, AJ (12) SS-2	Red Bluff (NS)				
15					
MOURITSEN, JUSTIN (11) CS-3 #7	Clovis (CS)				
F 1:37					
BAILEY, CARTER (10) NC-3 #15	Granada (NC)				
143					
YUKE, TONY (10) SJ-6	McClatchy (SJ)				
352					
VAUGHAN, ERIC (12) SS-6	Oak Hills (SS)				
144					
DEMERIS, NICO (11) SD-2	Mater Dei (SD)				
16					
NEGRET JR, CARLOS (10) CS-2 #2	Buchanan (CS)				
F .53					

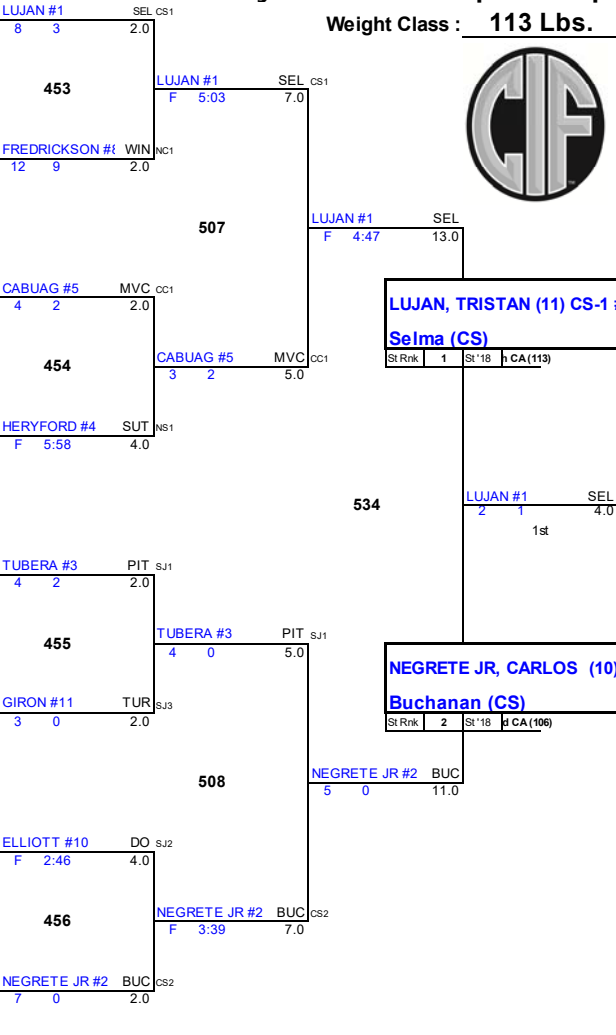

ROMAN	BIR	CHAVEZ	OC	CHAVEZ	OC
609		TF 16-0	2.5	F 2:57	3.0
CASTRO	DIN	721	AHOLELEI # YL	4	0
610		833	THOMPSON PAL	10	6
611		722	AHMED #12 PD	17	4
612		723	BOBZIEN #9 POW	5	2
613		724	SILVA #16 SRV	2	1
614		725	YUKE MCC	10	6
615		726	RUIZ SMI	9	8
616		727	ZINKIN #6 CN	5	2
		728	MCNEAL #1 JL	3	0

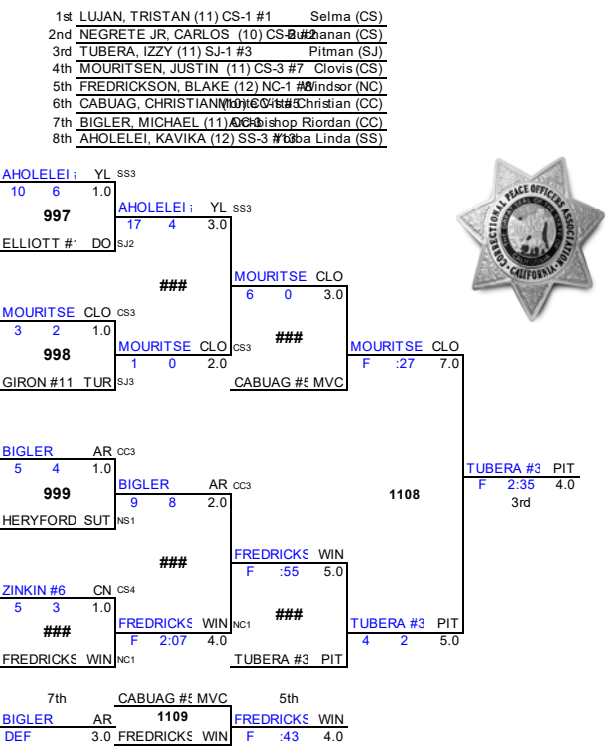

AHOLELEI, YL 7th  
BIGLER, AR DEF 3.0  
CABUAG #5 MVC 5th  
FREDRICKS, WIN F .43 4.0



# CIF Boys State Championship

Weight Class : **120 Lbs.**



GAYTAN, JESSE (11) CS-5 #16		Lemoore (CS) <b>145</b>		GAITAN	TV
GAITAN, M.J. (9) SS-5		Temecula Valley (SS)		2 0	4.0
RAMIREZ, ISRAEL (11) SD-2		San Ysidro (SD) <b>146</b>		RENTERIA #1	BUC
BASHOR, CLAYTON (10) SJ-4	Oakdale (SJ)	17	RENTERIA #1	BUC	4.0
RENTERIA, MAXIMO (10) CS-1 #1		Buchanan (CS)		F :50	4.0
GOULD, ETHAN (11) SS-4 #9		Esperanza (SS) <b>147</b>		GOULD #9	ESP
THAI, GIOVANNI (12) SF-1		Lowell (SF)		TF 15-0	5.5
APPLETON, JAY T (9) CS-T		Frontier (CS) <b>148</b>		DIXON #8	PVY
DUNCAN, DYLAN (12) SJ-6	Vista del Lago (SJ)	18	DIXON #8	PVY	4.0
DIXON, SAVION (12) SS-3 #8		Paloma Valley (SS)		F :30	4.0
PETRUSKE, GUS (12) NC-1 #12		College Park (NC) <b>149</b>		PETRUSKE #12	CP
MAGSINO, RALPH (11) SD-4		Olympian (SD)		F 2:49	6.0
LOPEZ, DONTE (9) CC-2		Gilroy (CC) <b>150</b>		LORENZO #5	SJB
LEIA, KIMO (9) CS-8	Kingsburg (CS)	19	LORENZO #5	SJB	2.0
LORENZO, ANTONIO (12) SS-1 #5		St. John Bosco (SS)		7 5	2.0
SCHUMM, GABRIEL (10) SS-6 #13		Citrus Hill (SS) <b>151</b>		SCHUMM #13	CH
COHN, MARCO (10) OS-1		Oakland Tech (OS)		F :45	6.0
FLOREZ, MARCO (10) CS-9		Exeter (CS) <b>152</b>		CRUZ #4	CN
THORNTON, BILLY (11) NS-1	Sutter (NS)	20	CRUZ #4	CN	3.0
CRUZ, JOEY (9) CS-4 #4		Clovis North (CS)		TF 21-6	3.5
PAULSON, BRANDON (12) CS-3 #3		Clovis (CS) <b>153</b>		PAULSON #3	CLO
DACLAN, VINCENT (12) SS-7		Santa Monica (SS)		F 1:39	6.0
GAITAN, JAKE (12) NC-2		Las Lomas (NC) <b>154</b>		NIIMI #14	GB
BAÑUELOS, DARIEN (11) LA-1	Carson (LA)	21	NIIMI #14	GB	3.0
NIIMI, KAI (12) SJ-3 #14		Granite Bay (SJ)		16 4	3.0
SCHANNEP, ISAAH (10) SJ-2 #11		Whitney (SJ) <b>155</b>		SCHANNEP #11	WHI
DOMINGUEZ, SEBASTIAN (12) SS-3		Alemany (SS)		2 1	4.0
NGUYEN, HARRISON (11) CC-3		Evergreen Valley (C) <b>156</b>		SAURIOL #6	POW
ARREOLA, LORENZO (12) CS-6	Dinuba (CS)	22	SAURIOL #6	POW	5.0
SAURIOL, CARSON (12) SD-1 #6		Poway (SD)		10 0	5.0
RUIZ, TJ (12) SJ-1 #10		Vacaville (SJ) <b>157</b>		RUIZ #10	VAC
GARCIA, RAUL (12) SD-3		Mt. Miguel (SD)		F 3:07	6.0
MARCHETTI, NOLAN (12) NC-3		Freedom (NC) <b>158</b>		CASTRO-SAN DOVAL #	SYN
MURPHY, JAMES (12) CS-7	Central (CS)	23	CASTRO-SAN DOVAL #	SYN	3.5
CASTRO-SAN DOVAL, RICHARD (11) SS-2		Santa Ynez (SS)		F 2:40	4.0
RIVERA, JACOB (11) CS-2 #2		Selma (CS) <b>159</b>		RIVERA #2	SEL
UYESAKA, KADE (12) SS-9		Dos Pueblos (SS)		16 9	4.0
NICKERSON, RUSSEL (10) NS-2		Quincy (NS) <b>160</b>		ARENAS #15	LN-CC
PRIM, CARSON (10) SJ-5	Grace Davis (SJ)	24	ARENAS #15	LN-CC	2.0
ARENAS, ADAM (11) CC-1 #15		Lincoln-SJ (CC)		11 0	3.0

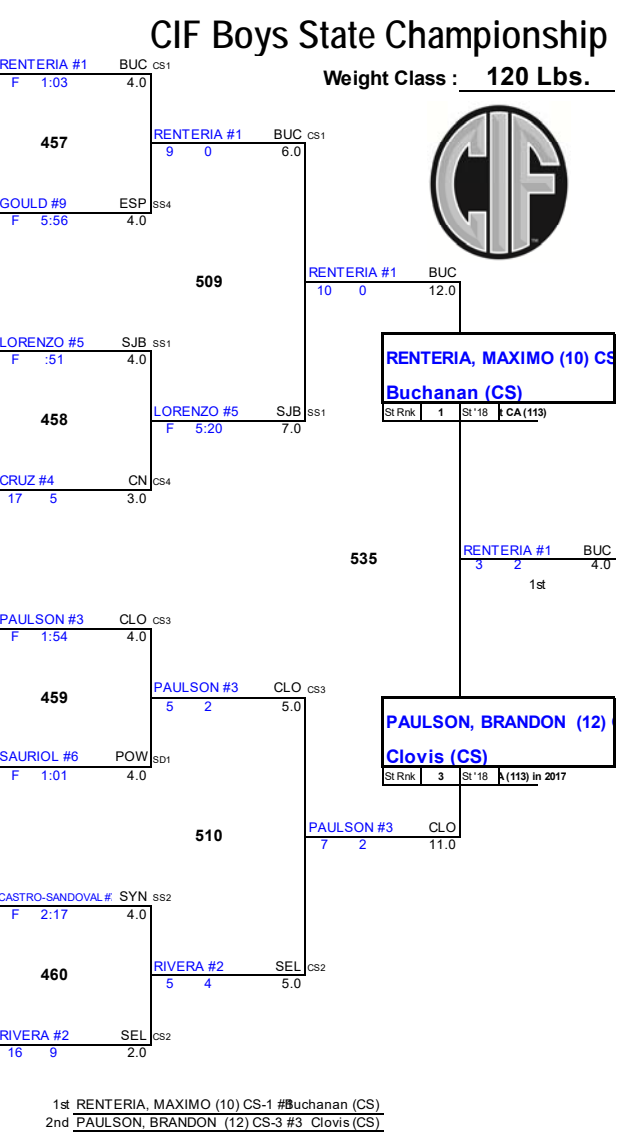

BASHOR	OKD	BASHOR	OKD	BASHOR	OKD
DACLAN	SMC	12 2	2.0	GAITAN	LI
DUNCAN	VDL	729	SCHUMM #1	CH	F 4:19 3.0
DOMINGUEZ	ALE	841	NGUYEN	EV	9 5 1.0
LEIA	KNG	730	PETRUSKE	CP	F 2:40 3.0
GARCIA	MMG	15 4	2.0	LEIA	KNG
THORNTON	SUT	731	MARCHETTI	FRD	F 4:39 3.0
UYESAKA	DP	6 4	1.0	UYESAKA	DP
BAÑUELOS	CRS	732	NICKERSON	QUI	7 0 1.0
GAYTON #16	LEM	12 5	1.0	GAYTON #1	LEM
ARREOLA	DIN	733	RAMIREZ	SY	2 1 1.0
THAI	LOW	TF 16-0	2.5	ARREOLA	DIN
MURPHY	CEN	734	APPLETON	FRQ	6 1 1.0
MAGSINO	OLY	9 1	2.0	MURPHY	CEN
PRIM	GD	735	LOPEZ	GIL	F 2:55 3.0
COHN	OT	F :52	3.0	FLOREZ	EXT
		736	NICKERSON	EXT	11 6 1.0
			NIIMI #14	GB	4 3 1.0

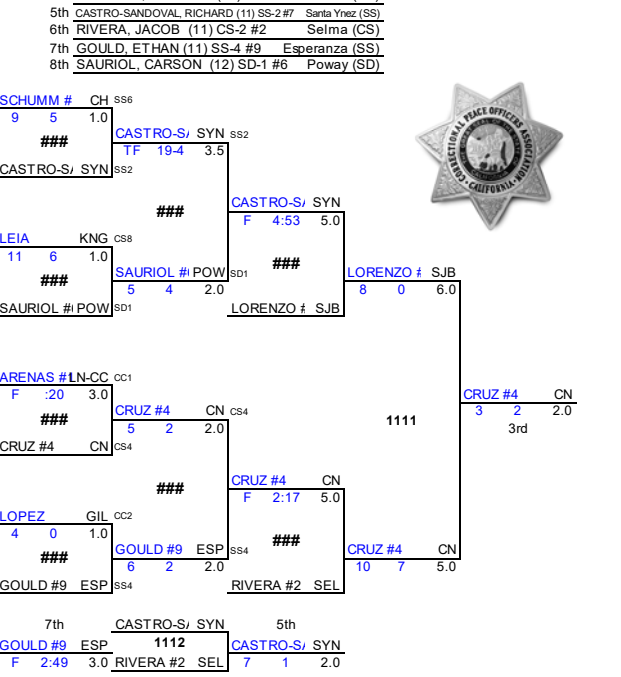

# CIF Boys State Championship

Weight Class : **126 Lbs.**



NAGAO, AARON (11) SS-1 #1	ESP	3.0	
Esperanza (SS) 161	NAGAO #1	TF 17-1	5.5
BLACKWELL, EUJ (11) SJ-6	TF	4 2	4.0
Tracy (SJ)	361		
WANG, ANDREW (12) CC-2	WANG	PA	4.0
Palo Alto (CC) 162			
LEPE #16	SFR	12 4	2.0
LEPE, KOBE (12) LA-1 #16	10 6	2.0	
San Fernando (LA)	UNPINGCO, DAKOTA (12) NC-1 #9	FRD	5.5
Freedom (NC) 163	UNPINGCO #9	FRD	5.5
MENDOZA, KOREY (11) SS-9	TF	15-0	3.0
Yucaipa (SS) 362			
MOLINA, DAYMEOND (12) SS-7	LEAKE #8	BUC	5.0
Canyon Springs (SS) 164	LEAKE #8	BUC	5.0
SCHWAEBE, ALEXANDER (11) SD-2	LEAKE #8	BUC	5.0
San Diego (SD) 26	LEAKE #8	BUC	5.0
LEAKE, HUNTER (11) CS-2 #8	3	0.0	
Buchanan (CS)	HERAS, ADRIAN (11) SJ-1 #12	TUR	6.0
Turlock (SJ) 165	HERAS #12	TUR	6.0
GONZALEZ, FERNANDO (9) CS-3	F	4:32	6.0
Sanger (CS) 363			
HERRERA, RICHY (11) SS-8	JOINT #5	LEM	4.0
Sonora (SS) 166	JOINT #5	LEM	4.0
STEVENS, DALLAS (10) NS-2	JOINT #5	LEM	4.0
Gridley (NS) 27	JOINT #5	LEM	4.0
JOINT, WAYNE (10) CS-1 #5	6 1	2.0	
Lemoore (CS)	IVALDI, EVAN (10) SJ-2 #13	EXT	5.0
Del Oro (SJ) 167	OLEA	EXT	5.0
OLEA, ERIK (12) CS-7	11 2	5.0	
Exeter (CS) 364			
NGUYEN, ANDY (11) SD-3	Mira Mesa (SD) 168	REYES	6.0
Mira Mesa (SD) 168	REYES	HAN	6.0
REYES, GABRIEL (11) CS-T	REYES	HAN	6.0
Hanford (CS) 28	REYES	HAN	6.0
MURPHY, OUT (11) CS-3 #2	0 0	2.0	
Clovis North (CS)	NUNEZ, CHRISTAN (12) SS-2 #4	BA	5.5
Bishop Amat (SS) 169	NUNEZ #4	BA	5.5
ANTONIO, CHRISTIAN (10) CC-3	TF	25-9	5.5
Evergreen Valley (CC) 365			
RHOADS, AUSTIN (9) CS-5	RHOADS	CLO	4.0
Clovis (CS) 170	RHOADS	CLO	4.0
ALANIS #14	FRA	5 1	4.0
Temecula Valley (SS) 29	ALANIS #14	FRA	4.0
ALANIS, EDISON (12) SJ-3 #14	7 3	2.0	
Franklin-EG (SJ)	SPANGLER, RYAN (11) SS-3 #11	SUL	6.0
Sultana (SS) 171	SPANGLER #11	SUL	6.0
LAWRENCE, ROYAL (10) OS-1	F	4:40	6.0
Oakland Tech (OS) 366			
SHIRAR, CONNER (12) SJ-5	REYES #6	FRO	2.0
Vacaville (SJ) 172	REYES #6	FRO	2.0
RUFFINELLI, MARCO (12) NC-3	REYES #6	FRO	2.0
Las Lomas (NC) 30	REYES #6	FRO	2.0
REYES, COLE (12) CS-6 #6	2 0	2.0	
Frontier (CS)	JACINTO, VICTOR (10) CC-1 #7	GIL	4.0
Gilroy (CC) 173	JACINTO #7	GIL	4.0
GARZA, CEASAR (9) SJ-4	3 1	4.0	
Oakdale (SJ) 367			
MAGANA, MARCOS (12) SS-4	Servite (SS) 174	VALDOVINOS #10	2.0
Servite (SS) 174	VALDOVINOS #10	CW	2.0
GEVORKYAN, OUT (12) SF-1	VALDOVINOS #10	CW	2.0
Lowell (SF) 31	VALDOVINOS #10	CW	2.0
VALDOVINOS, RAUL (10) CS-4 #10	DEF	4.0	
Clovis West (CS)	HILT, RILEY (12) NC-2 #15	MORA	4.0
Hilt, Riley (12) NC-2 #15	De La Salle (NC) 175	MORA	4.0
De La Salle (NC) 175	MORA, JAKE (12) NS-1	7 6	4.0
Pleasant Valley (NS) 368			
LEVINE, MICAH (12) SD-4	Mt Carmel (SD) 176	MIRANDA #3	4.0
Mt Carmel (SD) 176	MIRANDA #3	POW	4.0
VALENCIA, JASON (12) SS-6	MIRANDA #3	POW	4.0
Northview (SS) 32	MIRANDA #3	POW	4.0
MIRANDA, JASON (11) SD-1 #3	2 0	2.0	
Poway (SD)			

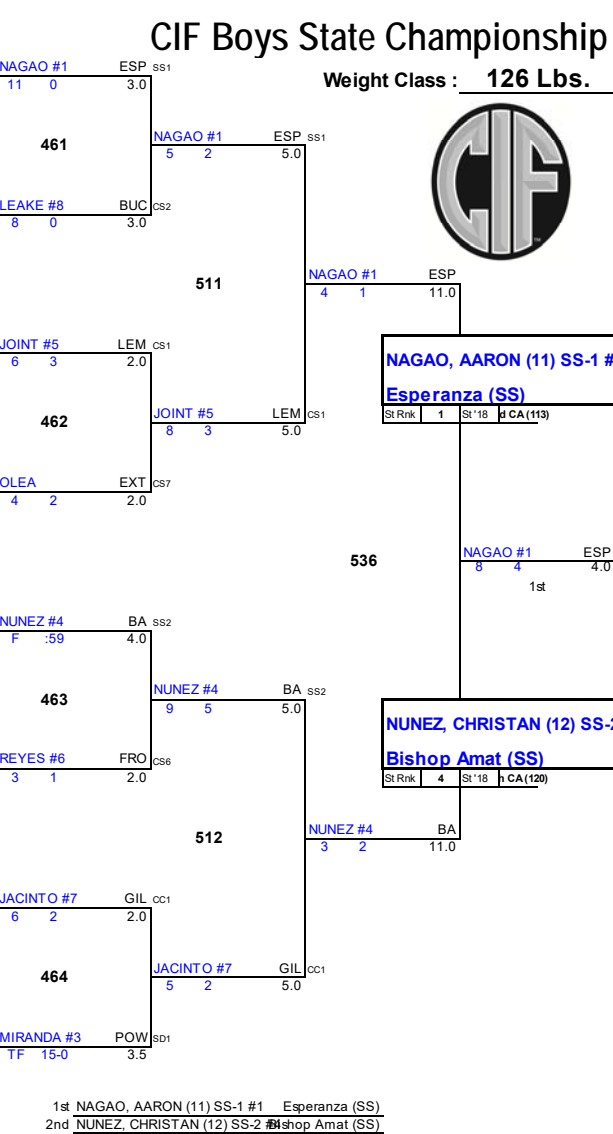

ANTONIO 625	EV	F	2:33	3.0	ALANIS #14	FRA	3 0	1.0	ALANIS #14	FRA	3 0	1.0	
SCHWAEBE 626	OT	5 0	1.0	SCHWAEBE	SD	849	8 4	1.0	HERAS #12	TUR	8 1	1.0	
LAWRENCE	SHIRAR	VAC	8 4	1.0	HERAS #12	TUR	F	:36	3.0	HERAS #12	TUR	8 1	1.0
STEVENS	GRI	738	HERAS #12	TUR	F	:36	3.0	HERAS #12	TUR	8 1	1.0	HERAS #12	TUR
GARZA	OKD	2 0	1.0	GARZA	OKD	850	5 2	1.0	UNPINGCO	FRD	5 2	1.0	
GARZA	OKD	2 0	1.0	GARZA	OKD	850	5 2	1.0	UNPINGCO	FRD	5 2	1.0	
MURPHY #2	CN	739	UNPINGCO #	FRD	5 2	1.0	UNPINGCO	FRD	5 2	1.0	UNPINGCO	FRD	
HILT #15	DLS	HILT #15	DLS	851	950	4 3	1.0	UNPINGCO	FRD	5 2	1.0	UNPINGCO	
HILT #15	DLS	0.0	MCA	F	3:43	4.0	HILT #15	DLS	4 3	1.0	UNPINGCO	FRD	
TAKARA	TV	740	WANG	PA	12 2	2.0	HILT #15	DLS	4 3	1.0	UNPINGCO	FRD	
TAKARA	TV	740	WANG	PA	12 2	2.0	HILT #15	DLS	4 3	1.0	UNPINGCO	FRD	
BLACKWELL	TRY	F	4:10	3.0	LEPE #16	SFR	12 4	2.0	LEPE #16	SFR	12 4	2.0	
BLACKWELL	TRY	F	4:10	3.0	LEPE #16	SFR	12 4	2.0	LEPE #16	SFR	12 4	2.0	
RUFFINELLI	LL	741	MORA	PV	14 6	2.0	LEPE #16	SFR	12 4	2.0	LEPE #16	SFR	
RUFFINELLI	LL	741	MORA	PV	14 6	2.0	LEPE #16	SFR	12 4	2.0	LEPE #16	SFR	
MENDOZA	YUC	8 1	1.0	MENDOZA	YUC	951	11 3	2.0	MENDOZA	YUC	11 3	2.0	
MENDOZA	YUC	8 1	1.0	MENDOZA	YUC	951	11 3	2.0	MENDOZA	YUC	11 3	2.0	
GEVORKYAN	LOW	742	VALDOVINO	CW	DEF	3.0	MENDOZA	YUC	11 3	2.0	MENDOZA	YUC	
GEVORKYAN	LOW	742	VALDOVINO	CW	DEF	3.0	MENDOZA	YUC	11 3	2.0	MENDOZA	YUC	
GONZALEZ	SAN	DEF	3.0	HERRERA	SO-SS	8 7	1.0	MENDOZA	YUC	11 3	2.0	MENDOZA	
GONZALEZ	SAN	DEF	3.0	HERRERA	SO-SS	8 7	1.0	MENDOZA	YUC	11 3	2.0	MENDOZA	
VALENCIA	NVW	743	SPANGLER	SUL	F	1:19	3.0	MENDOZA	YUC	11 3	2.0	MENDOZA	
VALENCIA	NVW	743	SPANGLER	SUL	F	1:19	3.0	MENDOZA	YUC	11 3	2.0	MENDOZA	
IVALDI #13	DO	2 0	1.0	VALENCIA	NVW	855	2 0	1.0	SPANGLER	SUL	3 2	3.0	
IVALDI #13	DO	2 0	1.0	VALENCIA	NVW	855	2 0	1.0	SPANGLER	SUL	3 2	3.0	
NGUYEN	MM	F	3:49	3.0	RHOADS	CLO	2 0	1.0	SPANGLER	SUL	3 2	3.0	
NGUYEN	MM	F	3:49	3.0	RHOADS	CLO	2 0	1.0	SPANGLER	SUL	3 2	3.0	
744	RHOADS	CLO	2 0	1.0	RHOADS	CLO	2 0	1.0	SPANGLER	SUL	3 2	3.0	
744	RHOADS	CLO	2 0	1.0	RHOADS	CLO	2 0	1.0	SPANGLER	SUL	3 2	3.0	
856	RHOADS	CLO	2 0	1.0	RHOADS	CLO	2 0	1.0	SPANGLER	SUL	3 2	3.0	
856	RHOADS	CLO	2 0	1.0	RHOADS	CLO	2 0	1.0	SPANGLER	SUL	3 2	3.0	

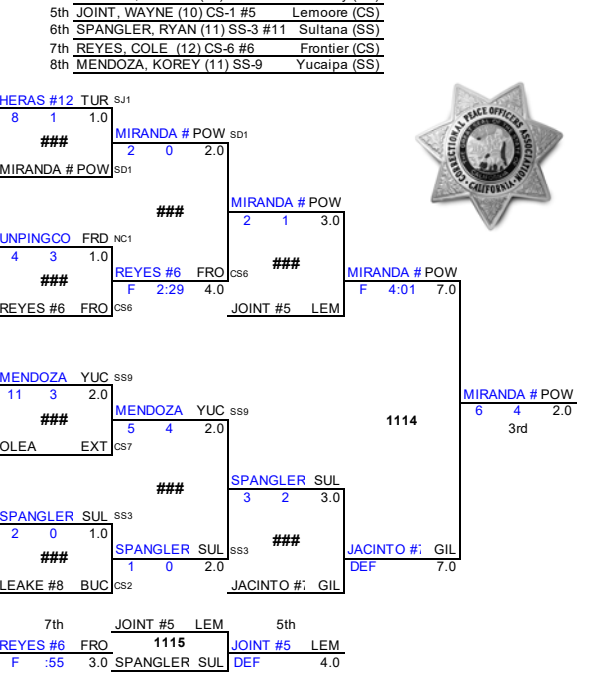

REYES #6	FRO	7th	JOINT #5	LEM	5th			
1116	REYES #6	FRO	1115	JOINT #5	LEM			
MENDOZA	YUC	F	:55	3.0	SPANGLER	SUL	DEF	4.0

# CIF Boys State Championship

Weight Class : **132 Lbs.**



PARCO, KYLE (12) NC-1#1	De La Salle (NC) 177	PARCO #1	DLS
TANNER, PORTER (11) CS-7	Paso Robles (CS) 369	F 4:41	6.0
HOLMAN, DEVIN (12) SJ-4	Burlingame (CC) 178	GAYER #16	CCH
El Capitan (SJ) 33	GAYER #16	TF 20-3	3.5
GAYER, LUKE (9) SS-4 #16	9 3	2.0	
Calvary Chapel (SS)	PETRUCELLI, GIANO (10) CS-2 #8	Clovis (CS) 179	PETRUCELLI #8
	RUDKIN, ALEX (10) NS-2	F 1:44	6.0
	Chico (NS) 370	F 3:49	4.0
ELGARICO, RYAN (12) SJ-5	HALLMARK, CHAZ (12) SD-1	Scripps Ranch (SD) 180	MEDINA #9
Eik Grove (SJ) 34	MEDINA #9	F 3:49	4.0
MEDINA, JOSHUA (11) SS-3 #9	11 5	2.0	
Servite (SS)	FERNANDEZ III, JOSE (12) NC-2 #5	Upper Lake (NC) 181	FERNANDEZ III #5
	CHIW, EDDIE (11) SD-3	F 1:59	6.0
	Mira Mesa (SD) 371	F 5:41	6.0
CASTRO, NOAH (12) CC-1	St. John Bosco (SS) 182	LEVINE	SJB
Gilroy (CC) 35	LUCIO #12	F 5:41	6.0
LUCIO, CADE (10) CS-5 #12	7 2	2.0	
Bakersfield (CS)	JOHNSON, BRENDEN (11) SJ-3 #13	Del Oro (SJ) 183	JOHNSON #13
	YESCAS, SANTIAGO (10) SF-1	F 2:42	6.0
	Washington (SF) 372	F 2:37	4.0
CHIRINO, BRADLEY (12) SS-8	MIRANDA, JUDE (12) CS-8	Hanford (CS) 184	PORTER #4
Bonita (SS) 36	PORTER #4	F 2:37	4.0
PORTER, HENRY (10) SJ-1 #4	13 4	3.0	
Oakdale (SJ)	POLANCO, MARCOS (12) SS-1 #3	Bishop Amat (SS) 185	POLANCO #3
	RODRIGUEZ, ALEX (11) CS-9	F 1:29	6.0
	Redwood (CS) 373	F 1:29	6.0
MELENDEZ, NICK (12) CC-3	STOODARD, ZANE (11) SD-2	Poway (SD) 186	PERALTA #14
Branham (CC) 37	PERALTA #14	VAC 2 1	2.0
PERALTA, JACOB (12) SJ-6 #14	11 7	2.0	
Vacaville (SJ)	GIOFFRE, LOGAN (11) CS-4 #11	Buchanan (CS) 187	GIOFFRE #11
	NAVA, DIEGO (12) LA-1	15 1	5.0
	Birmingham (LA) 374	F 2:57	4.0
KROESEN, STEVEN (12) SS-7	KEPHART, ISAAC (12) CS-T	Arroyo Grande (CS) 188	MIRELEZ #6
Laguna Hills (SS) 38	MIRELEZ #6	F 4:51	4.0
MIRELEZ, NOAH (12) SJ-2 #6	HAYES, COLLIN (11) SS-2 #7	Northview (SS) 189	HAYES #7
Patterson (SJ)	RABY, ROCKY (11) NS-1	TF 18-2	5.5
	West Valley (NS) 375	F 3:00	3.0
HELLER, DANIEL (12) SS-9	CARDENAS, EZRA (11) SD-4	Steele Canyon (SD) 190	VIVEROS #10
Beverly Hills (SS) 39	VIVEROS #10	KNG 11 3	3.0
VIVEROS, JONATHON (10) CS-3 #10	15 7	3.0	
Kingsburg (CS)	FRANCO, RYAN (10) CS-1 #2	Clovis North (CS) 191	FRANCO #2
	LUNA, SUNNY (12) SS-6	6 2	4.0
	Victor Valley (SS) 376	TF 17-2	3.5
OTHMAN, BASIL (11) NC-3	HIBERT, EMMANUEL (12) OS-1	Skyline (OS) 192	OTHMAN
Benicia (NC) 40	OTHMAN	F 1:01	4.0
FLETCHER, GARRETT (11) CS-6 #15	8 1	2.0	
Frontier (CS)			

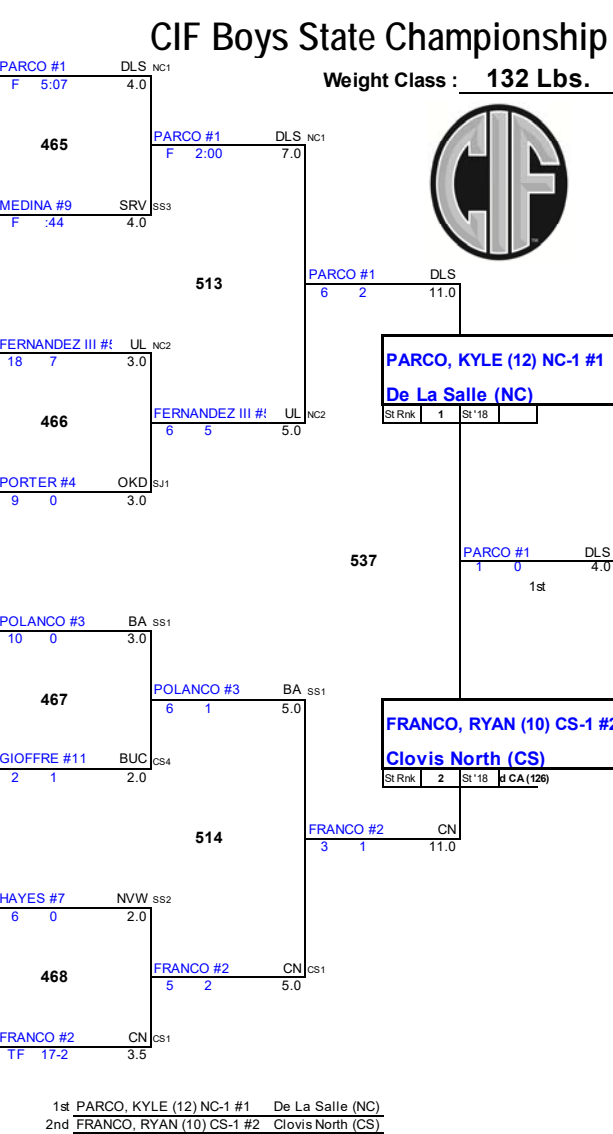

**132 Lbs.**

- 1st PARCO, KYLE (12) NC-1 #1 De La Salle (NC)
- 2nd FRANCO, RYAN (10) CS-1 #2 Clovis North (CS)
- 3rd PORTER, HENRY (10) SJ-1 #4 Oakdale (SJ)
- 4th PETRUCELLI, GIANO (10) CS-2 #8 Clovis (CS)
- 5th FERNANDEZ III, JOSE (12) NC-2 #5 Upper Lake (NC)
- 6th POLANCO, MARCOS (12) SS-1 #3 Bishop Amat (SS)
- 7th MEDINA, JOSHUA (11) SS-3 #9 Servite (SS)
- 8th JOHNSON, BRENDEN (11) SJ-3 #13 Del Oro (SJ)

HOLMAN	ECP	HOLMAN	ECP	STOODARD	POW	RODRIGUEZ	RED	F :52	3.0	STOODARD	POW	9 2	1.0	JOHNSON #	DO
633		745		JOHNSON #	DO	F 3:00	3.0	ELGARICO	EG	857		6 0	1.0	JOHNSON #	DO
ELGARICO	EG	857		ELGARICO	EG	8 0	2.0	NAVA	BIR	8 0	2.0	ELGARICO	EG	8 0	2.0
634		746		LEVINE	SJB	F 4:40	3.0	CASTRO	GIL	858		6 0	1.0	JOHNSON #	DO
NAVA	BIR	8 0	2.0	CASTRO	GIL	11 3	2.0	RABY	WV-NS	11 3	2.0	CASTRO	GIL	858	
635		747		PETRUCELL	CLO	F 2:12	3.0	CARDENAS	SCN	F 2:12	3.0	PETRUCEL	CLO	953	
CHIRINO	BON	747		PETRUCELL	CLO	F 3:50	3.0	CHIRINO	BON	747		PETRUCEL	CLO	954	
LUNA	VV	12 4	2.0	LUNA	VV	F :53	3.0	LUNA	VV	12 4	2.0	LUNA	VV	8 0	2.0
636		748		GAYER #16	CCH	F 3:00	3.0	MELENDEZ	BRA	748		GAYER #16	CCH	8 0	2.0
MELENDEZ	BRA	748		TANNER	PR	TF 16-0	2.5	TANNER	PR	TF 16-0	2.5	BOTELHO	BUR	860	
TANNER	PR	TF 16-0	2.5	BOTELHO	BUR	F 4:49	3.0	KROESEN	LHL	749		OTHMAN	BEN	9 3	1.0
637		749		OTHMAN	BEN	9 3	1.0	KROESEN	LHL	749		OTHMAN	BEN	9 3	1.0
KROESEN	LHL	749		HALLMARK	SR	6 5	1.0	RUDKIN	CHC	TF 17-0	2.5	HALLMARK	SR	6 5	1.0
638		750		HALLMARK	SR	10 2	2.0	HELLER	BHL	750		VIVEROS #1	KNG	10 2	2.0
HELLER	BHL	750		HELLER	BHL	862		HELLER	BHL	750		VIVEROS #1	KNG	10 2	2.0
CHIW	MM	TF 22-7	2.5	LUCIO #12	BAK	8 5	1.0	CHIW	MM	TF 22-7	2.5	LUCIO #12	BAK	8 5	1.0
639		751		LUCIO #12	BAK	10 5	1.0	FLETCHER #15	FRO	751		MIRELEZ #6	PAT	10 5	1.0
FLETCHER #15	FRO	751		FLETCHER #	FRO	863		YESCAS	WA-SF	TF 15-0	2.5	FLETCHER #	FRO	9 4	1.0
YESCAS	WA-SF	TF 15-0	2.5	FLETCHER #	FRO	863		640		752		PERALTA #	VAC	9 4	1.0
640		752		PERALTA #	VAC	F 3:00	3.0					PERALTA #	VAC	9 4	1.0
				864								864			

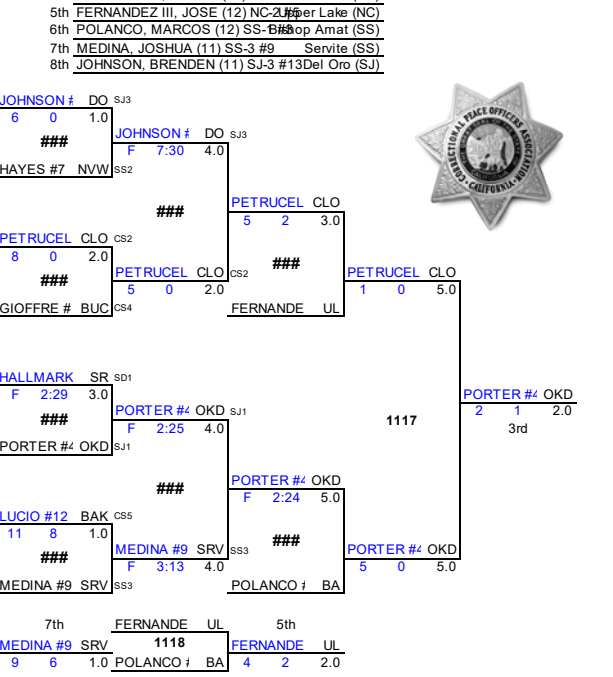

JOHNSON # DO 7th FERNANDEZ UL 5th  
 1119 MEDINA #9 SRV 9 6 1.0 1118 FERNANDEZ UL 4 2 2.0  
 MEDINA #9 SRV 9 6 1.0 POLANCO # BA 4 2 2.0

# CIF Boys State Championship

Weight Class : **138 Lbs.**



VASQUEZ, JESSE (11) SS-1#1 Excelsior Charter (S) 193 LEON, DOMINICK (10) CS-T Golden Valley (CS) 377	VASQUEZ #1 F 2:52 6.0	EXC SS1 4.0	VASQUEZ #1 F :39	EXC SS1 4.0	VASQUEZ #1 F 3:15	EXC SS1 7.0	VASQUEZ, JESSE (11) SS-1 Excelsior Charter (SS)				
BIRCH, ETHAN (9) SJ-5 Vacaville (SJ) 41 SEPUVEDA, TYLER (10) CS-5 #16 Selma (CS)	SEPUVEDA #16 SEL 7 6 4.0	LL 4.0	MONJARES, JOSIAH (12) NC-2 Las Lomas (NC) 194 MONJARES	LL 4.0	LE, JADEN (11) SD-1 #8 Rancho Bernardo (S) 195 OST, JAMES (12) CC-2 Fremont (CC) 378 CHAVEZ, MERE (12) NS-2 Chico (NS) 196 RAMIREZ RAMIREZ #10 2 3.0	RBE 6.0 RBE SD1 3.5	VASQUEZ #1 F :39	EXC 13.0	VASQUEZ #1 F :39	EXC 13.0	VASQUEZ, JESSE (11) SS-1 Excelsior Charter (SS)
RAMIREZ, ISAIAH (12) SS-6 Barstow (SS) 42 MORPHIS, RYAN (12) CS-3 #9 Frontier (CS)	RAMIREZ #10 2 3.0	BAR 2.0	ARROYO, LUCIANO (12) SS-2 #5 Calvary Chapel (SS) 197 MILLER, MICHAEL (12) SJ-6 Central Valley (SJ) 379 JACKSON, JETT (10) CS-7 Kingsburg (CS) 198 ROWLAND #12 ROWLAND #12 CHM 7 2 2.0	CCH 5.0 CCH 2.0	ARROYO #5 10 4 2.0	CCH SS2 5.0	VASQUEZ #1 F :39	EXC 13.0	VASQUEZ #1 F :39	EXC 13.0	VASQUEZ, JESSE (11) SS-1 Excelsior Charter (SS)
GRAY, OUT (12) OS-1 Oakland Tech (OS) 43 ROWLAND, PATRICK (12) SS-9 #12 Chaminade (SS)	DEF 4.0	CHM 2.0	BLOEMHOF, ANDREW (12) CS-2 #4 Bakersfield (CS) 199 VILLA, DAVID (10) SS-5 Citrus Hill (SS) 380 LOBOS, DESI (10) LA-1 Birmingham (LA) 200 NAVIDA	BAK 5.0 BAK 2.0	BLOEMHOF #4 11 1 5.0	BAK CS2 2.0	VASQUEZ #1 F :39	EXC 13.0	VASQUEZ #1 F :39	EXC 13.0	VASQUEZ, JESSE (11) SS-1 Excelsior Charter (SS)
NAVIDA, CHRISTIAN (11) SD-3 San Marcos (SD) 44 WATTS, ZACH (11) CS-4 #13 Clovis North (CS)	NAVIDA SMR F 3:21 4.0	SMR 4.0	GUERRERO, DWAYNE (12) NC-1 #14 De La Salle (NC) 201 MURABITO, CLAYTON (12) CC-3 Los Gatos (CC) 381 SAMANO, ISAAC (11) SS-8 Don Lugo (SS) 202 DEEN #3 DEEN #3 BUC 10 0 3.0	DLS 4.0 DLS 4.0 BUC 4.0	DEEN #3 F 2:32 4.0	BUC CS1 2.0	VASQUEZ #1 F :39	EXC 13.0	VASQUEZ #1 F :39	EXC 13.0	VASQUEZ, JESSE (11) SS-1 Excelsior Charter (SS)
GUTIERREZ, DAKOTA (11) SJ-4 Bella Vista (SJ) 45 DEEN, TYLER (12) CS-1 #3 Buchanan (CS)	DEEN #3 BUC 10 0 3.0	BUC 3.0	TORRES, RICKEY (12) SJ-1 #6 Oakdale (SJ) 203 PEREZ, ANGEL (11) CS-6 Firebaugh (CS) 382 TOLENTINO, NOAH (9) SD-2 Poway (SD) 204 OKADA #11 OKADA #11 SRV 16 3 3.0	OKD 4.0 OKD 4.0 SRV 3.0	DEEN #3 F 2:32 4.0	BUC CS1 2.0	VASQUEZ #1 F :39	EXC 13.0	VASQUEZ #1 F :39	EXC 13.0	VASQUEZ, JESSE (11) SS-1 Excelsior Charter (SS)
NASCIMENTO, JONAH (12) SF-1 Lowell (SF) 46 OKADA, TEDDY (12) SS-4 #11 Servite (SS)	OKADA #11 SRV 16 3 3.0	SRV 3.0	PEREZ, BEAU (12) SS-3 #10 San Marino (SS) 205 SANCHEZ, COLE (11) NC-3 Northgate (NC) 383 ZUNIGA, GEORGE (11) CS-8 Central (CS) 206 BLAKE #7 BLAKE #7 DO 7 3 2.0	SMI 4.0 SMI 2.0 DO 2.0	DEEN #3 F 2:32 4.0	BUC CS1 2.0	VASQUEZ #1 F :39	EXC 13.0	VASQUEZ #1 F :39	EXC 13.0	VASQUEZ, JESSE (11) SS-1 Excelsior Charter (SS)
MONTGOMERY, BONNER (11) NS-1 Chester (NS) 47 BLAKE, ELI (11) SJ-3 #7 Del Oro (SJ)	BLAKE #7 DO 7 3 2.0	DO 2.0	FRANK, KENDALL (12) SJ-2 #15 Elk Grove (SJ) 207 GUTIERREZ, JOSE (10) SD-4 Brawley (SD) 384 ARRANDA, OSCAR (9) SS-7 St. John Bosco (SS) 208 SALDATE #2 SALDATE #2 GIL 10 5 2.0	EG 5.0 EG 5.0 GIL 2.0	DEEN #3 F 2:32 4.0	BUC CS1 2.0	VASQUEZ #1 F :39	EXC 13.0	VASQUEZ #1 F :39	EXC 13.0	VASQUEZ, JESSE (11) SS-1 Excelsior Charter (SS)
LOGAN, AVINA, BARAJAS (11) CS-9 Clovis (CS) 48 SALDATE, CHASE (11) CC-1 #2 Gilroy (CC)	SALDATE #2 GIL 10 5 2.0	GIL 2.0	PEREZ, BEAU (12) SS-3 #10 San Marino (SS) 205 SANCHEZ, COLE (11) NC-3 Northgate (NC) 383 ZUNIGA, GEORGE (11) CS-8 Central (CS) 206 BLAKE #7 BLAKE #7 DO 7 3 2.0	SMI 4.0 SMI 2.0 DO 2.0	DEEN #3 F 2:32 4.0	BUC CS1 2.0	VASQUEZ #1 F :39	EXC 13.0	VASQUEZ #1 F :39	EXC 13.0	VASQUEZ, JESSE (11) SS-1 Excelsior Charter (SS)

BIRCH	VAC	MURABITO	LG	SAMANO	DL	NAVIDA	SMR
MURABITO	LG	4 3	1.0	4 3	1.0	4 2	1.0
MORPHIS #9	FRO	753	NAVIDA	SMR	4 2	1.0	
PEREZ	FIR	F 4:06	3.0	MORPHIS # FRO	5 3	1.0	
GRAY	OT	754	TOLENTINO	POW	8 1	1.0	
SANCHEZ	NG	DEF	3.0	ZUNIGA	CEN	F 3:27	3.0
WATTS #13	CN	755	ZUNIGA	CEN	F 3:27	3.0	
GUTIERREZ	BRW	WATTS #13	CN	867	RAMIREZ	BAR	F 4:53
GUTIERREZ	BVI	756	ARRANDA	SJB	8 2	1.0	
LEON	GV-CS	7 1	1.0	SEPUVEDA	SEL	5 3	1.0
NASCIMENTO	LOW	757	SEPUVEDA	SEL	5 3	1.0	
OST	FR-CC	14 1	2.0	CHAVEZ	CHC	11 2	2.0
MONTGOMERY	CHS	758	CHAVEZ	CHC	11 2	2.0	
MILLER	CVY	F 1:14	3.0	MILLER	CVY	F 1:39	3.0
LOGAN	CLO	759	JACKSON	KNG	F 1:39	3.0	
VILLA	CH	3 2	1.0	LOGAN	CLO	871	
		760	LOGAN	CLO	871		
			LOBOS	BIR	F 4:56	3.0	
					5 2	1.0	

OKADA #11 SRV	7th	ARROYO # CCH	5th
1122	BLAKE #7 DO	F 1:29	3.0
1121	DEEN #3 BUC	7 2	2.0

1st VASQUEZ, JESSE (11) SS-1 Excelsior Charter (SS)  
 2nd SALDATE, CHASE (11) CC-1 #2 Gilroy (CC)  
 3rd MORPHIS, RYAN (12) CS-3 #9 Frontier (CS)  
 4th LE, JADEN (11) SD-1 #8 Rancho Bernardo (SD)  
 5th DEEN, TYLER (12) CS-1 #3 Buchanan (CS)  
 6th ARROYO, LUCIANO (12) SS-2 #5 Calvary Chapel (SS)  
 7th BLAKE, ELI (11) SJ-3 #7 Del Oro (SJ)  
 8th OKADA, TEDDY (12) SS-4 #11 Servite (SS)



# CIF Boys State Championship

Weight Class : **145 Lbs.**



BORBA, SETH (10) SJ-2 #16	209	MORA	ESP
Oakdale (SJ)		F 5:56	6.0
MORA, JOEY (11) SS-8			
Esperanza (SS)	385		
MARTINO, NICK (12) CS-7	210	ABAS #1	RBE
Clovis (CS)		F 3:22	4.0
ABAS, JADEN (12) SD-1 #1	216	ABAS #1	RBE
Rancho Bernardo (SD)		F 3:22	4.0
WILSON, EARNEST (11) NS-1	212	MAGANA #9	SRV
Foothill (NS)		F 7 0	2.0
MAGANA, DANIEL (12) SS-4 #9	213	MARTIN #5	BUC
Servite (SS)		F 3:39	6.0
GONZALEZ, SAUL (12) CC-2	214	ROGERS #12	CRC
Palma (CC)		F 14 5	3.0
ROGERS, BROCK (12) CS-4 #12	215	SILVEIRA #13	PIT
Corcoran (CS)		F 3 0	4.0
SUMULONG, LOGAN (12) NC-3	216	WICK #4	SMI
De La Salle (NC)		F 1:44	4.0
WICK, LUKA (10) SS-2 #4	217	LANDIN	FRO
San Marino (SS)		F 8 7	4.0
JOHNSON, ERIK (10) SJ-4	218	SIHAVONG #3	BUL
Vista del Lago (SJ)		F 4 0	4.0
SIHAVONG, DAWSON (12) CS-1 #3	219	FOX #6	GIL
Bullard (CS)		F 1:53	6.0
RIOS, ADRIAN (12) SS-9	220	CUTTONE #11	CN
Bishop Amat (SS)		F 1 0	2.0
CUTTONE, VITO (12) CS-3 #11	221	CORTEZ #10	NVW
Clovis North (CS)		F 1:16	6.0
PIMENTEL, ALEX (10) NS-2	222	HANSEN #7	ROY
Pleasant Valley (NS)		F 1:50	4.0
HANSEN, JACOB (12) SS-3 #7	223	VALENCIA #2	SJB
Royal (SS)		F 4 0	4.0
CAMPOS, JED (10) SJ-5	224	PAULSON #15	LB-NC
Del Oro (SJ)		F 1:04	4.0
PAULSON, NATE (12) NC-2 #15			
Liberty (NC)			

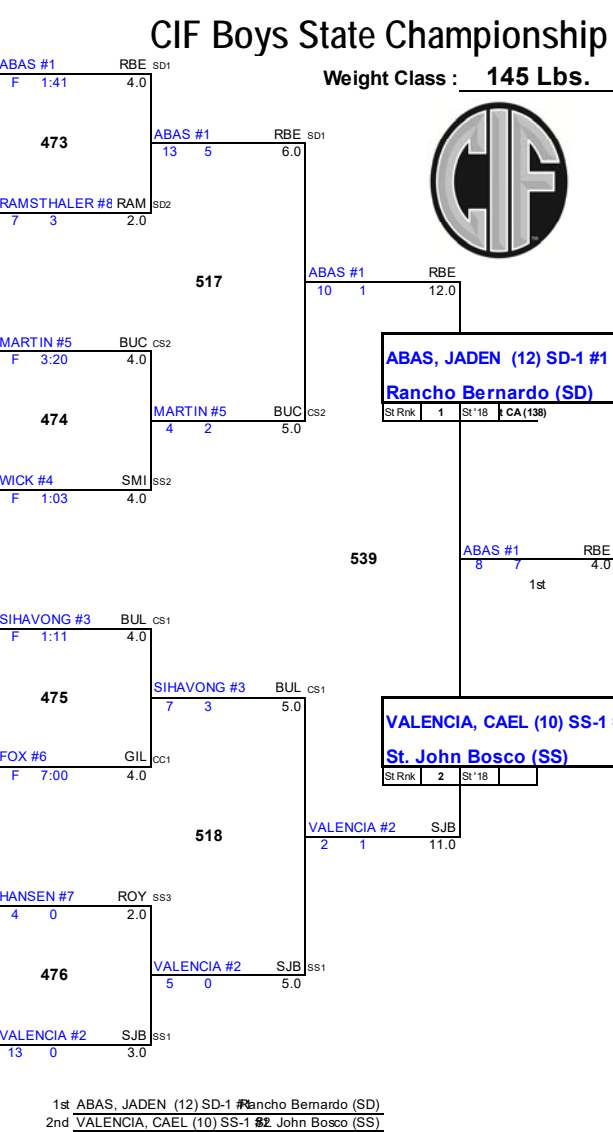

**145 Lbs.**

- 1st ABAS, JADEN (12) SD-1 #1 Rancho Bernardo (SD)
- 2nd VALENCIA, CAEL (10) SS-1 #2 St. John Bosco (SS)
- 3rd SIHAVONG, DAWSON (12) CS-1 #3 Bullard (CS)
- 4th MARTIN, JOSEPH (9) CS-2 #5 Buchanan (CS)
- 5th WICK, LUKA (10) SS-2 #4 San Marino (SS)
- 6th FOX, JOHN (12) CC-1 #6 Gilroy (CC)
- 7th RAMSTHALER, JEFF (12) SD-2 #8 Ramona (SD)
- 8th HANSEN, JACOB (12) SS-3 #7 Royal (SS)

MARTINO	CLO	SILVA #14	WIN	13	4	2.0	SILVA #14	WIN	13	4	2.0	SILVEIRA #	PIT
SILVA #14	WIN	HOULE	CV	DEF			DEF					SILVEIRA #	PIT
WILLSON	FH-NS	HART	IMP	873			873					ROGERS #	CRC
HART	IMP	MARTIN	VAC	5	2	1.0	MARTIN	VAC	5	2	1.0	ROGERS #	CRC
GONZALEZ	PAL	GONZALEZ	PAL	874			874					HANSEN #7	ROY
BUSTAMANTE	OAK	WILLS	CN-CS	F 1:29	3.0		GONZALEZ	PAL	F 1:24	3.0		MAGANA #	SRV
SUMULONG	DLS	SUMULONG	DLS	875			MAGANA #9	SRV	5	2	1.0	MAGANA #	SRV
KLAIR	MVC	MACHADO	GV-CS	F :48	3.0		SUMULONG	DLS	F :35	3.0		MORA	ESP
JOHNSON	VDL	BORBA #16	OKD	876			MORA	ESP	11	3	2.0	MORA	ESP
BORBA #16	OKD	RIYABOY	LOW	6	4	1.0	BORBA #16	OKD	6	4	1.0	PAULSON #	LB-NC
RIOS	BA	RIOS	BA	877			PAULSON #	LB-NC	6	0	1.0	PAULSON #	LB-NC
ESTRADA	BEY	SEKHON	CEN	3	0	1.0	SEKHON	CEN	4	0	1.0	SEKHON	CEN
PIMENTEL	PV	BOLLINGER	SUL	878			SEKHON	CEN	5	4	1.0	SEKHON	CEN
BOLLINGER	SUL	GALEF	BIR	F 1:42	3.0		CORTEZ #11	NVW	5	4	1.0	WICK #4	SMI
CAMPOS	DO	RODRIGUEZ	RIG	879			WICK #4	SMI	2	0	3.0	WICK #4	SMI
RODRIGUEZ	RIG	MORALES	POW	6	2	1.0	RODRIGUEZ	RIG	3	1	1.0	RAMSTHAL	RAM
		MORALES	POW	8	1	1.0	RODRIGUEZ	RIG	3	1	1.0	RAMSTHAL	RAM
		LANDIN	FRO	6	4	1.0	RODRIGUEZ	RIG	10	4	2.0	RAMSTHAL	RAM
				880			RAMSTHAL	RAM	10	4	2.0	SIHAVONG	BUL

HANSEN #7	ROY	7th	FOX #6	GIL	5th				
1125	RAMSTHAL	RAM	1124	WICK #4	SMI				
RAMSTHAL	RAM	8	4	1.0	WICK #4	SMI	6	3	2.0





# CIF Boys State Championship

Weight Class : 152 Lbs.



LUCHAU, JACE (12) CS-1 #1 Selma (CS) 225 ONTIVEROS, ISAAH (11) SJ-5 Pitman (SJ) 393 MURILLO, ARMANDO (12) SS-8 Rowland (SS) 57 GARCIA, NATHAN (12) CS-3 #16 Paso Robles (CS) 5 ANDERSON, MAX (12) CS-2 #8 Clovis (CS) 227 YAMBAO, KYMANI (12) SD-3 San Marcos (SD) 394 ROBLES, ZACHARY (12) SJ-4 Woodland (SJ) 58 VIZCARRA, DANIEL (12) CC-1 #8 Gilroy (CC) 15 BANDUENGA, DONBENI (12) CS-6 Righetti (CS) 59 SANTIAGO, SONNY (11) SS-2 #5 St. John Bosco (SS) DEF WILLIFORD, COREY (12) NS-2 Foothill (NS) 60 SPARKS, ANDREW (11) SS-5 #13 Calvary Chapel (SS) F 5:02 GARCIA, PATRICK (12) SJ-3 Modesto Christian (SJ) 61 MENDOZA, ALFREDO (12) CC-3 #14 Salinas (CC) 8 AVILA, HUNTER (12) CS-4 Monache (CS) 62 BADGETT, TYLER (11) SD-2 #6 Rancho Bernardo (SD) 1 BAKER, AIDAN (12) SD-4 La Costa Canyon (SD) 63 DUCHARME, TYEE (12) SJ-1 #7 Vacaville (SJ) F 5:35 HAGY, KEVIN (11) SJ-6 Rio Americano (SJ) 64 GANDARA, AARON (11) SD-1 #2 Poway (SD) F 2:56	LUCHAU #1 SEL F :55 6.0 393 PETERSEN, CONNOR (12) NC-3 Petaluma (NC) 226 GARCIA #16 PR 7 6 4.0 ANDERSON #9 CLO 10 1 5.0 VIZCARRA #8 GIL 6 3 2.0 Westminster (SS) 228 VIZCARRA #8 GIL F 5:45 4.0 BUCK, VALOR (11) SS-3 #12 Servite (SS) 229 METTLER, GAGE (12) NC-2 Northgate (NC) 395 ROCHA, ERIC (12) LA-1 San Fernando (LA) 230 SANTIAGO #5 SJB 11 1 3.0 MANTANONA, TROY (12) SS-1 #4 Palm Desert (SS) 231 ALMAGUER, EVAN (11) CS-8 Clovis North (CS) 396 KHAN, HASSAN (11) SJ-2 Franklin-EG (SJ) 232 WILLIFORD, FH-NS 10 5 2.0 STINSON, JT (11) NS-1 #3 East Nicolaus (NS) 233 STINSON #3 EN 8 2 4.0 GONZALEZ, ADRIAN (12) CS-7 Bakersfield (CS) 397 SMELSER, BRADEN (11) SS-7 Valencia/Valencia 234 MENDOZA #14 SAL F 2:15 4.0 OROZCO, JONATHAN (12) SS-4 #11 Oak Hills (SS) 235 OROZCO #11 OH F 1:24 6.0 FRANCO, MARIO (10) NC-1 De La Salle (NC) 398 NG, JALEN (12) SF-1 Lowell (SF) 236 BADGETT #6 RBE F 1:09 4.0 JIMENEZ, MARCOS (11) CC-2 #10 Evergreen Valley (C 237 SULLIVAN, JARRON (12) CS-T Redwood (CS) 399 STAFFORD, VINCENT (11) CS-9 Sanger (CS) 238 DUCHARME #7 VAC F 1:19 4.0 RAIZ, REY (10) CS-5 #15 Buchanan (CS) 239 MENDIETA, CAJ 7 6 4.0 MENDIETA, BRANDON (12) SS-8 Cajon (SS) 400 SUBBA, BIPLU (11) OS-1 Oakland (OS) 240 GANDARA #2 POW F :22 4.0
--	---

## 152 Lbs.

LUCHAU #1 SEL CS1 F :24 4.0 477 LUCHAU #1 SEL CS1 3 2 5.0 VIZCARRA #8 GIL CC1 6 3 2.0 519 SANTIAGO #5 SJB 3 2 11.0 SANTIAGO, SONNY (11) SS St. John Bosco (SS) St Rnk 5 St '18 CA(138)	SANTIAGO #5 SJB SS2 3 2 2.0 478 SANTIAGO #5 SJB SS2 4 2 5.0 540 SANTIAGO #5 SJB 3 2 4.0 1st	STINSON #3 EN NS1 F 3:22 4.0 479 BADGETT #6 RBE SD2 3 2 5.0 BADGETT #6 RBE SD2 5 3 2.0 520 BADGETT #6 RBE 3 2 11.0 BADGETT, TYLER (11) SD-2 Rancho Bernardo (SD) St Rnk 6 St '18	JIMENEZ #10 EV CC2 10 3 2.0 480 GANDARA #2 POW SD1 3 0 5.0 GANDARA #2 POW SD1 TF 15-0 3.5	BUCK #12 SRV SS3 4 3 1.0 BUCK #12 SRV SS3 5 2 2.0 JIMENEZ #10 EV CC2 ANDERSON CLO F .43 3.0 966 ANDERSON CLO CS2 5 1 1.0 STINSON # EN NS1 3 2 2.0 LUCHAU #1 SEL F 6:21 7.0	STINSON # EN F 2:07 5.0 LUCHAU #1 SEL F 6:21 7.0 DUCHARME VAC SJ1 4 0 1.0 DUCHARME VAC SJ1 14 12 2.0 1126 LUCHAU #1 SEL 5 2 2.0 3rd VIZCARRA : GIL F 3:44 5.0 KHAN FRA SJ2 6 3 1.0 VIZCARRA : GIL CC1 F 2:31 4.0 GANDARA : POW 5 3 5.0
--	---	--	---	---	---

- 1st SANTIAGO, SONNY (11) SS-2 #5 St. John Bosco (SS)
- 2nd BADGETT, TYLER (11) SD-2 #6 Rancho Bernardo (SD)
- 3rd LUCHAU, JACE (12) CS-1 #1 Selma (CS)
- 4th GANDARA, AARON (11) SD-1 #2 Poway (SD)
- 5th STINSON, JT (11) NS-1 #3 East Nicolaus (NS)
- 6th VIZCARRA, DANIEL (12) CC-1 #8 Gilroy (CC)
- 7th DUCHARME, TYEE (12) SJ-1 #7 Vacaville (SJ)
- 8th BUCK, VALOR (11) SS-3 #12 Servite (SS)



MURILLO, ARMANDO (12) SS-8 Rowland (SS) 57 GARCIA, NATHAN (12) CS-3 #16 Paso Robles (CS) 5 ANDERSON, MAX (12) CS-2 #8 Clovis (CS) 227 YAMBAO, KYMANI (12) SD-3 San Marcos (SD) 394 ROBLES, ZACHARY (12) SJ-4 Woodland (SJ) 58 VIZCARRA, DANIEL (12) CC-1 #8 Gilroy (CC) 15 BANDUENGA, DONBENI (12) CS-6 Righetti (CS) 59 SANTIAGO, SONNY (11) SS-2 #5 St. John Bosco (SS) DEF WILLIFORD, COREY (12) NS-2 Foothill (NS) 60 SPARKS, ANDREW (11) SS-5 #13 Calvary Chapel (SS) F 5:02 GARCIA, PATRICK (12) SJ-3 Modesto Christian (SJ) 61 MENDOZA, ALFREDO (12) CC-3 #14 Salinas (CC) 8 AVILA, HUNTER (12) CS-4 Monache (CS) 62 BADGETT, TYLER (11) SD-2 #6 Rancho Bernardo (SD) 1 BAKER, AIDAN (12) SD-4 La Costa Canyon (SD) 63 DUCHARME, TYEE (12) SJ-1 #7 Vacaville (SJ) F 5:35 HAGY, KEVIN (11) SJ-6 Rio Americano (SJ) 64 GANDARA, AARON (11) SD-1 #2 Poway (SD) F 2:56	FRANCO DLS 6 5 1.0 FRANCO DLS F 1:30 3.0 BUCK #12 SRV 5 1 1.0 SULLIVAN RED DEF 3.0 STAFFORD SAN 5 4 1.0 ANDERSON CLO F .43 3.0 966 ANDERSON CLO CS2 5 1 1.0 STINSON # EN NS1 3 2 2.0 LUCHAU #1 SEL F 6:21 7.0
--	---

BUCK #12 SRV 1128 DUCHARME VAC 4 2 1.0	7th STINSON # EN 1127 VIZCARRA : GIL 6 1 2.0	5th STINSON # EN 6 1 2.0
---	--	--------------------------------

# CIF Boys State Championship

Weight Class : **160 Lbs.**



VILLARREAL, NATHAN (12) CC-1 #16		GILROY (CC) <b>241</b>		VILLARREAL #16		GILROY (CC) <b>241</b>	
LUSSIER, LUKE (12) SS-5		11 2		5.0		5.0	
Victor Valley (SS)		<b>401</b>		OLGUIN #1		BUC	
THORNBERG, ALEX (12) SJ-6		Vista del Lago (SJ) <b>242</b>		OLGUIN #1		BUC	
Trabuco Hills (SS)		65		OLGUIN #1		BUC	
OLGUIN, MATTHEW (12) CS-1 #1		F 2:32		4.0		4.0	
Buchanan (CS)		ZAVALA, NICHOLAS (11) CS-3 #9		ZAVALA #9		MO	
		Mission Oak (CS) <b>243</b>		F 3:40		6.0	
		SOTO, ZACH (12) NS-2		Chico (NS)		<b>402</b>	
		ISAIAS, BRIAN (12) SS-7		Villa Park (SS) <b>244</b>		HERNANDEZ #8	
MALONE, COULTER (12) SJ-5		Vacaville (SJ)		HERNANDEZ #8		POW	
66		HERNANDEZ, ALEX (11) SD-1 #8		7 0		2.0	
Poway (SD)		SCARPONI, MICHAEL (12) SS-3 #12		Temecula Valley (S) <b>245</b>		SCARPONI #12	
		MYRTUE, EVAN (12) SJ-3		6 2		4.0	
		El Capitan (SJ)		SANCHEZ, JADEN (11) CS-6		<b>403</b>	
		Bakersfield (CS) <b>246</b>		ENKHMAMDAKH #5		DLS	
ORTIZ, PAUL (10) SD-3		Imperial (SD)		ENKHMAMDAKH #5		DLS	
67		De La Salle (NC)		WILNER, MAX (10) SS-1 #4		Fountain Valley (S) <b>247</b>	
		Fountain Valley (S) <b>247</b>		WILNER #4		FV	
		LEWALLEN, RILEY (12) SJ-4		F 3:44		6.0	
		Ponderosa (SJ)		<b>404</b>		WILNER #4	
		HOURI, BEN (12) SD-4		La Costa Canyon (S) <b>248</b>		GARCIA #13	
BRAR, YADWINDER (11) CS-8		Clovis East (CS)		GARCIA #13		KEL	
68		GARCIA, ALEX (12) NC-2 #13		F 3:03		4.0	
Katsyville (NC)		AGUIRRE, MAX (12) CS-2 #3		Frontier (CS) <b>249</b>		AGUIRRE #3	
		CORTAZ, TONY (12) SS-4		F 1:31		6.0	
		Centennial Corona (SS)		COLIAS, PETER (11) SF-1		<b>405</b>	
		Galileo (SF)		PRUIS #14		HER	
BROPHY, KURT (12) CC-2		Carmel (CC)		PRUIS #14		HER	
69		PRUIS, CODY (12) NC-3 #14		8 3		2.0	
Heritage (NC)		LAROSA, KENDALL (11) SJ-2 #6		Pitman (SJ)		LAROSA #6	
		BUSCHER, KYLE (12) SS-6		F 3:44		6.0	
		Oak Hills (SS)		HANSEN, LUKE (12) LA-1		<b>406</b>	
		Palisades (LA) <b>252</b>		SMITH #11		BRW	
SHERWOOD, REID (12) CS-7		Clovis North (CS)		SMITH #11		BRW	
70		SMITH, JAYDEN (12) SD-2 #11		F 2:24		4.0	
Brawley (SD)		ROJAS, LOUIS (12) SS-2 #7		St. John Bosco (SS) <b>253</b>		ROJAS #7	
		HERNANDEZ, ISAIAS (11) CS-T		Selma (CS)		<b>407</b>	
		VELA, CARLOS (12) CC-3		Branham (CC) <b>254</b>		KLOSTER #10	
HANCOCK, ZAC (12) NS-1		Sutter (NS)		KLOSTER #10		LEM	
71		KLOSTER, WILL (11) CS-4 #10		5 2		2.0	
Lemoore (CS)		CHIARAMONTE, MIKELLI (11) CS-5 #15		Clovis (CS) <b>255</b>		CHIARAMONTE #15	
		GONZALES, T.J. (10) OS-1		F 1:17		6.0	
		Skyline (OS)		GRANTHAM, TAYTE (9) CS-9		<b>408</b>	
		Madera South (CS) <b>256</b>		BLAKE #2		DO	
HATCHER, COBE (12) SS-8		Mayfair (SS)		BLAKE #2		DO	
72		BLAKE, NOAH (12) SJ-1 #2		F :53		4.0	
Del Oro (SJ)							

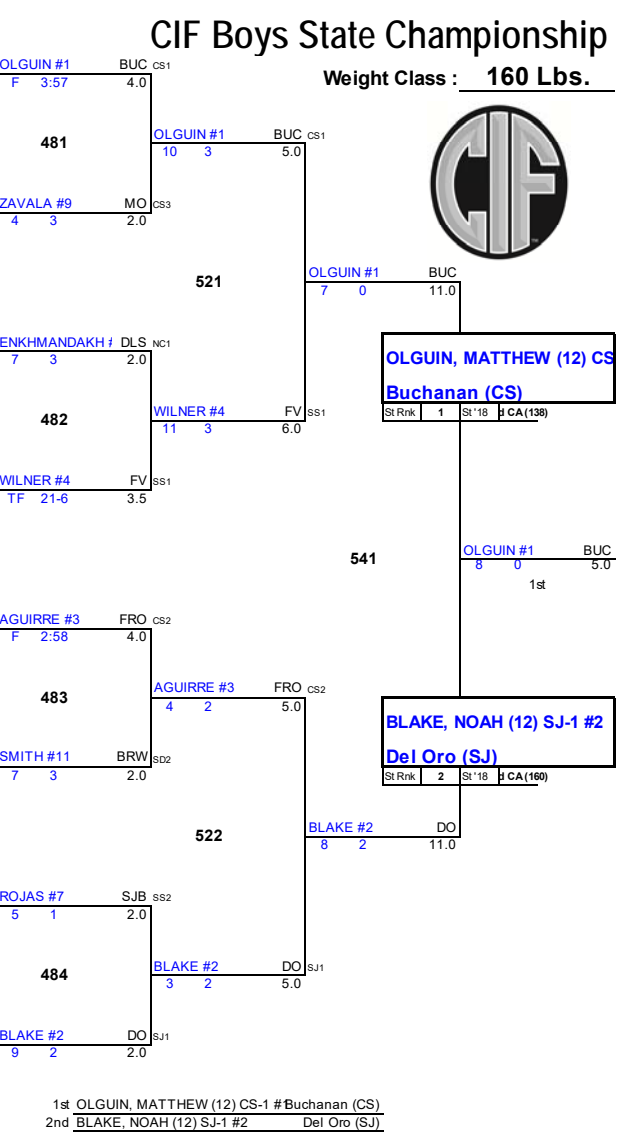

NICHOLSON TH		NICHOLSON TH		NICHOLSON TH		NICHOLSON TH	
CORTEZ CN-SS		F :07		3.0		3.0	
665		COULIAS		F 1:25		3.0	
MALONE VAC		777		GARCIA #13 KEL		6 0 1.0	
BUSCHER OH		6 5		1.0		1.0	
666		HANSEN PLS		6 5		1.0	
ORTIZ IMP		778		SCARPONI # TV		F 4:10 3.0	
HERNANDEZ SEL		7 0		1.0		1.0	
667		VELA BRA		F 1:29		3.0	
BRAR CE		779		HERNANDEZ POW		F 1:14 3.0	
GONZALES SKY		F 1:36		3.0		3.0	
668		GRANTHAM MS		F 4:02		3.0	
BROPHY CAR		780		VILLARREAL GIL		F 2:07 3.0	
LUSSIER VV		7 2		1.0		1.0	
669		THORNBERG VDL		F 2:02		3.0	
SHERWOOD CN		781		CHIARAMONTE CLO		F 2:35 3.0	
SOTO CHC		4 0		1.0		1.0	
670		ISAIAS VP		F 3:36		3.0	
HANCOCK SUT		782		KLOSTER # LEM		6 1 1.0	
MYRTUE ECP		8 2		1.0		1.0	
671		SANCHEZ BAK		11 6		1.0	
HATCHER MAY		783		LAROSA #6 PIT		2 0 1.0	
LEWALLEN PON		F 1:28		3.0		3.0	
672		HOURI LCC		F 3:23		3.0	
		784		PRUIS #14 HER		F 3:30 3.0	
				896			

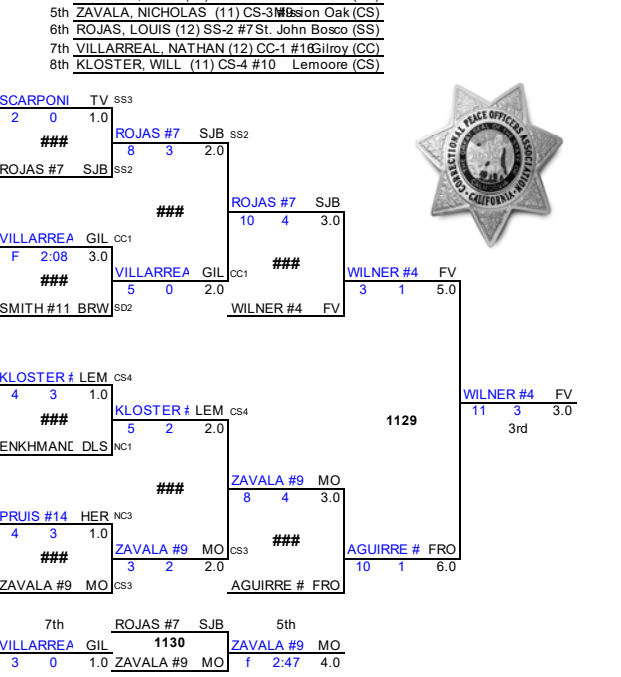

VILLARREAL GIL		7th		ROJAS #7 SJB		5th	
1131		VILLARREAL GIL		1130		ZAVALA #9 MO	
KLOSTER # LEM		3 0		1.0		ZAVALA #9 MO	
						f 2:47 4.0	

# CIF Boys State Championship

Weight Class : **170 Lbs.**



MUNOZ, TREY (12) SS-1 #1	Trabuco Hills (SS) <b>257</b>	MUNOZ #1	TH
REESE, ANDREW (12) SJ-6	Vista del Lago (SJ)	F :57	6.0
REDFERN, MATEO (12) NS-2	West Valley (NS) <b>258</b>	RUPP	MAR
RUPP, NOAH (11) SD-2	Maranatha Christian (SD) <b>73</b>	RUPP	MAR
FRANTZICH, AUSTIN (12) CS-5 #16	Clovis (CS)	F 4:00	4.0
BARNES, JOSEPH (12) CC-1 #9	Gilroy (CC) <b>259</b>	BARNES #9	GIL
MANCIA, SALVADOR (12) SS-6	Cajon (SS)	10 1	5.0
HACKETT, LANCE (11) NC-3	De La Salle (NC) <b>260</b>	MARTINEZ #8	OKD
LANDIN, CHRISTIAN (10) CS-7	Frontier (CS) <b>74</b>	MARTINEZ #8	OKD
MARTINEZ, GABRIEL (12) SJ-1 #8	Oakdale (SJ)	F 5:49	4.0
LONG, DANIEL (12) CS-6 #5	Dinuba (CS) <b>261</b>	LONG #5	DIN
MORRIS, ISAAC (11) NC-2	Castro Valley (NC)	F 1:53	6.0
CARTER, NEIL (11) SS-5	Servite (SS) <b>262</b>	CHAPMAN #12	VAC
LEGASPI, FELIPE (10) OS-1	Skyline (OS) <b>75</b>	CHAPMAN #12	VAC
CHAPMAN, COLE (12) SJ-4 #12	Vacaville (SJ)	F 2:30	4.0
STEPHENS, KODIAK (10) SJ-5 #13	Bret Harte (SJ) <b>263</b>	STEPHENS #13	BHA
VISCONTE, COLE (12) CS-8	Morro Bay (CS)	6 4	4.0
PEREZ, JEZZIEL (10) LA-1	Cleveland (LA) <b>264</b>	COSIO #4	TV
HILL, TIMOTHY (12) SD-4	Mira Mesa (SD) <b>76</b>	COSIO #4	TV
COSIO, RYAN (12) SS-2 #4	Temecula Valley (SS)	11 2 3.0	4.0
CARDWELL, MARK (12) CS-2 #3	Monache (CS) <b>265</b>	CARDWELL #3	MON
ZIDAREVICH, ZACH (12) SD-3	Rancho Bernardo (SD)	F :38	6.0
SPAINHOWARD, JUSTIN (11) CS-	Ridgeview (CS) <b>266</b>	GARCIA #14	VP
OWNBY, ETHAN (12) NS-1	Durham (NS) <b>77</b>	GARCIA #14	VP
GARCIA, JOAQUIN (11) SS-3 #14	Villa Park (SS)	F 3:49	4.0
CONTINO, ROCCO (10) CS-3 #6	Buchanan (CS) <b>267</b>	CONTINO #6	BUK
BUCHANAN, TRAVIS (11) SS-8	Hemet (SS)	F 3:49	6.0
HAK, ZANIE (11) CC-2	Bellamine Prep (C) <b>268</b>	MYLES #11	OKM
BOSSERT, TATE (11) NC-1	Las Lomas (NC) <b>78</b>	MYLES #11	OKM
MYLES, SEAN (10) SJ-3 #11	Oakmont (SJ)	9 2 2.0	4.0
PRIEST, JARAD (11) CS-4 #7	Bakersfield (CS) <b>269</b>	PRIEST #7	BAK
VENTURA-SEPULVEDA, JESUS (11)	Centennial Corona (SS)	F 1:31	6.0
HERNANDEZ, IVAN (12) SD-1	Poway (SD) <b>270</b>	VALDEZ #10	PLA
MICALLEF, JUSTIN (10) CS-9	Yosemite (CS) <b>79</b>	VALDEZ #10	PLA
VALDEZ, JOSEPH (12) SJ-2 #10	Placer (SJ)	F 1:46	4.0
GAUNT, BARON (11) SS-4 #15	West Torrance (SS) <b>271</b>	GAUNT #15	WT
SONG, MAXWELL (12) SF-1	Lowell (SF) <b>416</b>	PIEARCY, ROBERT (12) CC-3	RODRIGUEZ #2
BELTRAN, MIGUEL (12) SS-9	St. John Bosco (SS) <b>80</b>	RODRIGUEZ #2	SEL
RODRIGUEZ, CHRISTIAN (12) CS-1 #2	Selma (CS)	F 2:22	4.0

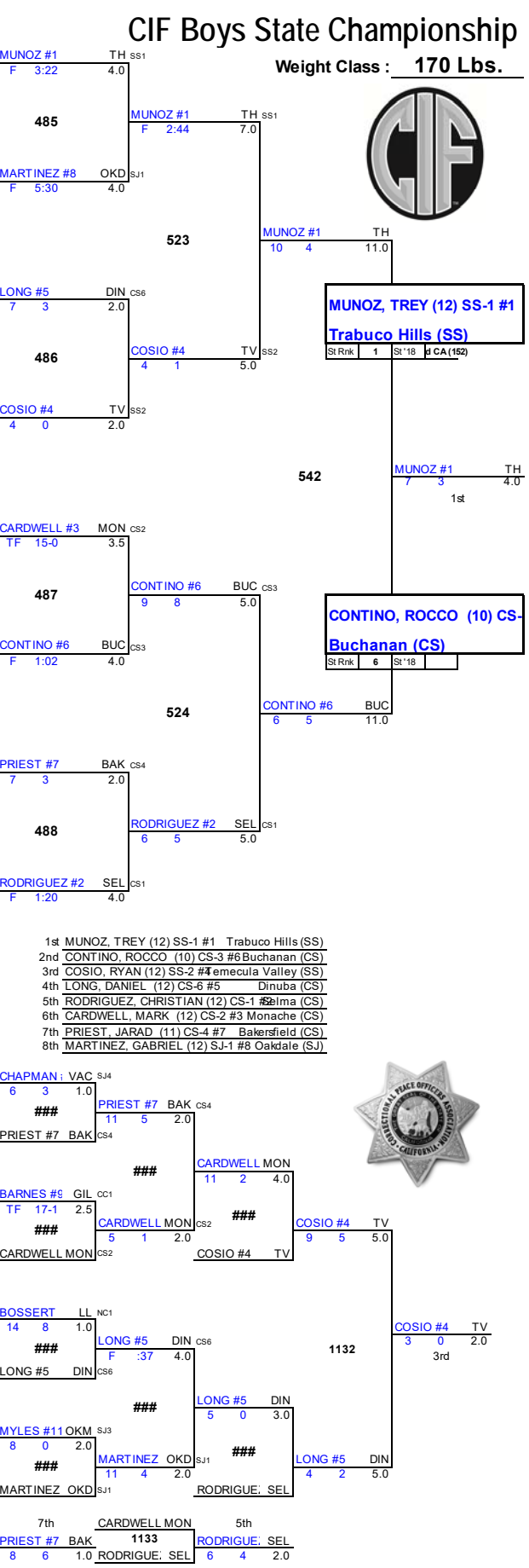

FRANTZICH #16	CLO	FRANTZICH #16	CLO
ZIDAREVICH	RBE	7 1 1.0	FRANTZICH CLO
LANDIN	FRO	785	STEPHENS BHA
WUERTH	HEM	13 1 2.0	LANDIN FRO
LEGASPI	SKY	786	CHAPMAN # VAC
VENTURA-SEPULVEDA	CN-SS	F :14 3.0	HERNANDEZ POW
HILL	MM	787	BARNES #9 GIL
SONG	LOW	12 1 2.0	PIEARCY CUP
OWNBY	DUR	788	RUPP MAR
REESE	VDL	6 3 1.0	REESE VDL
BOSSERT	LL	789	GAUNT #15 WT
MANCIA	CAJ	12 2 2.0	BOSSERT LL
MICALLEF	YOS	790	VALDEZ #10 PLA
MORRIS	CSV	9 1 2.0	CARTER SRV
BELTRAN	SJB	791	MYLES #11 OKM
VISCONTE	MB	8 6 1.0	BELTRAN SJB
		792	GARCIA #14 VP



PRIEST #7 BAK	7th	CARDWELL MON	5th
1134	PRIEST #7 BAK	1133	RODRIGUEZ SEL
MARTINEZ OKD	8 6 1.0	RODRIGUEZ SEL	6 4 2.0

# CIF Boys State Championship

Weight Class : 182 Lbs.



TRACY, TRENT (12) CS-1#1	Frontier (CS) 273	TRACY #1	FRO	6.0
RODRIGUEZ, JOSEPH (10) SS-5	Paramount (SS) 417	GARCIA #16	SEL	4.0
KOHL, ANDREW (12) NC-2	Castro Valley (NC) 274	GARCIA #16	SEL	4.0
REYES, MARCOS (12) CC-3	Aptos (CC) 81	GARCIA #16	SEL	4.0
GARCIA, RUDY (11) CS-7 #16	Selma (CS)	CURTIS, JOE (11) SD-2 #8	LCC	5.0
	La Costa Canyon (S) 275	CURTIS #8	LCC	5.0
	GRIFITHS, JACOB (11) SJ-4	Ponderosa (SJ) 418	LCC	3.0
	DARBINIAN, KHAJACK (12) SS-7	San Clemente (SS) 276	ANNIS #9	BAK
MCCOY, BOBBY (12) NS-1	Chico (NS) 82	ANNIS #9	BAK	4.0
ANNIS, JORDAN (12) CS-3 #9	Bakersfield (CS)	LEWIS, MALIK (12) SJ-1 #5	FRA	4.0
	Franklin-EG (SJ) 277	TINKER, TREVOR (11) SS-9	Bonita (SS) 419	FRA
	SHARP, PAUL (9) CS-9	Clovis North (CS) 278	SHARP	CN
PEASE, BRADEN (9) SD-3	Poway (SD) 83	HANESSIAN #12	SV	6.0
HANESSIAN, NICO (12) SS-2 #12	Simi Valley (SS)	GUTIERREZ, DALLAS (10) CC-2 #13	GILroy (CC) 279	GIL
	MANNION, ANDREW (10) CS-8	Clovis East (CS) 420	SMITH #4	BIR
	SHENG, DIEGO (12) SS-6	Peninsula (SS) 280	SMITH #4	BIR
BORDON, JOHN (12) CS-T	Ridgeview (CS) 84	SMITH #4	BIR	2.0
SMITH, JONOVAN (12) LA-1 #4	Birmingham (LA)	MABRY, DENZEL (12) OS-1 #14	Castlemon (OS) 281	MABRY #14
	ROCHA, CESAR (12) SJ-6	Turlock (SJ) 421	RAMIREZ, ANTONIO (12) SD-4	Escondido (SD) 282
	GIANAKOPOULOS, TYLER (11) CS-2 #3	Clovis (CS) 85	GIANAKOPOULOS #3	CLO
	RAWLS, CARSTEN (10) CC-1 #11	Saint Francis (CC) 283	MAEZ	AGR
	MAEZ, ISAAC (11) CS-6	Arroyo Grande (CS) 422	HARKEY, JOSH (11) SS-3	Dana Hills (SS) 284
LECKIE, LUAM (12) SJ-3	Vista del Lago (SJ) 86	KILNER #6	GRA	2.0
KILNER, JACK (12) NC-1 #6	Granada (NC)	RODRIGUEZ, FELIPE (11) CS-4 #10	Clovis West (CS) 285	RODRIGUEZ #10
	MCCREADIE, KAIMANA (12) SS-5	Irvine (SS) 423	GIANGREGORIO, DONIVAN (10) SS-5	Calaveras (SJ) 286
	GIANGREGORIO, DONIVAN (10) SS-5	Calaveras (SJ) 286	JOVERO #7	RBE
CELAYA, MATEO (12) NC-3	St. Patrick St. Vincent (NC) 87	JOVERO #7	RBE	2.0
JOVERO, JAVEN (10) SD-1 #7	Rancho Bernardo (SD)	HAAS, NATHAN (11) SS-1 #2	St. John Bosco (SS) 287	HAAS #2
	ELKO, AIDEN (12) SJ-5	Jesuit (SJ) 424	BALINTON, MARINO (12) SF-1	Galileo (SF) 288
LAMBERT, CADE (11) NS-2	West Valley (NS) 88	MANZO #15	CHO	4.0
MANZO, LUCIANO (12) CS-5 #15	Chowchilla (CS)			

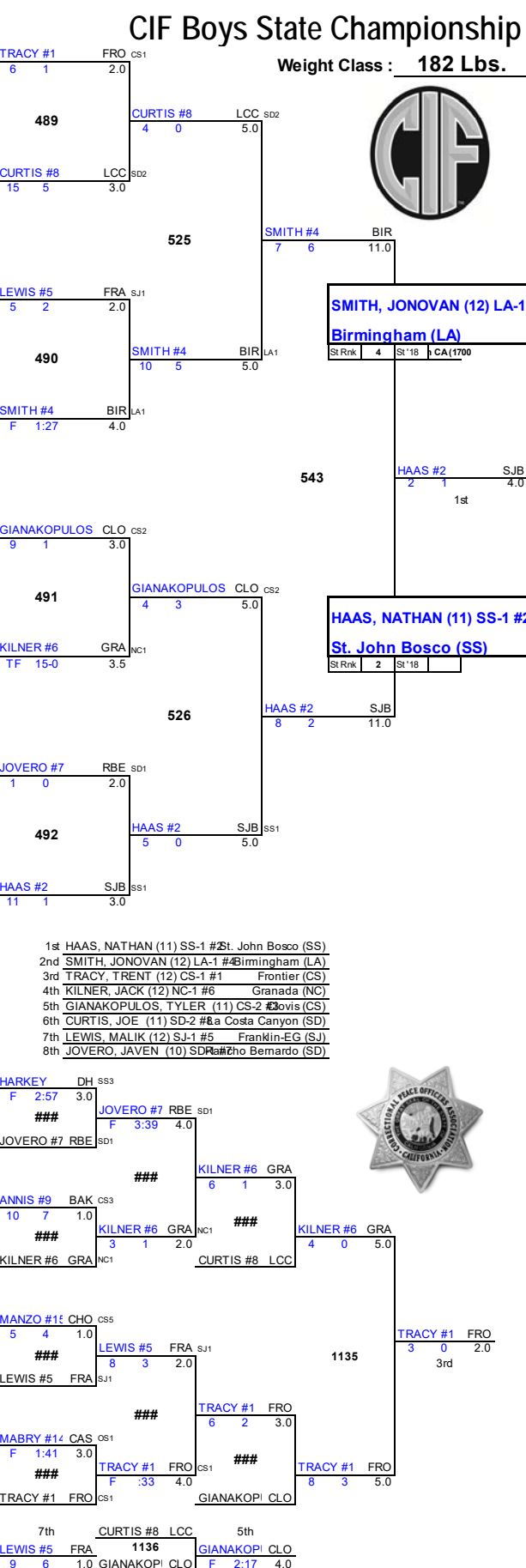

REYES	APT	REYES	APT	RAMIREZ	ESC	GUTIERREZ, GIL
ROCHA	TUR	6	5	1.0	F 3:37	3.0
MCCOY	CHC	793	GUTIERREZ, GIL	F	:49	3.0
RAWLS #11	SF	F 2:49	3.0	HARKEY	DH	977
682	HARKEY	DH	F :27	3.0	HARKEY	DH
PEASE	POW	794	SHARP	CN	17	3
	MCCREADIE	IRV	906	GIANGREGO	CLV	
683	GIANGREGO	CLV	6	0	1.0	
BORDON	RID	795	ANNIS #9	BAK	8	3
	BORDON	RID	907	ANNIS #9	BAK	1.0
ELKO	JES	6	3	1.0	BORDON	RID
684	BALINTON	GAL	10	5	1.0	
LYLES	MAY	796	GARCIA #16	SEL	DEF	3.0
	LYLES	MAY	908	MANZO #15	CHO	
RODRIGUEZ	PRM	6	3	1.0	MANZO #15	CHO
685	KOHL	CSV	6	0	1.0	
LECKIE	VDL	797	MANZO #15	CHO	12	8
	LECKIE	VDL	909	MANZO #15	CHO	3.0
GRIFITHS	PON	F 1:30	3.0	LECKIE	VDL	979
686	DARBINIAN	SCL	3	2	1.0	
CELAYA	SPV	798	RODRIGUEZ, CW	6	1	1.0
	TINKER	BON	910	LEWIS #5	FRA	
TINKER	BON	13	1	2.0	LEWIS #5	FRA
687	HANESSIAN #12	SV	F 2:00	3.0	HANESSIAN	SV
LAMBERT	WV-NS	799	MAEZ	AGR	4	0
	MANNION	CE	911	MAEZ	AGR	1.0
MANNION	CE	7	3	1.0	SHENG	PEN
688	SHENG	PEN	5	3	1.0	
	800	MABRY #14	CAS	6	2	1.0
		912				



JOVERO #7 RBE	7th	CURTIS #8 LCC	5th
1137	LEWIS #5 FRA	1136	GIANAKOPI CLO
LEWIS #5 FRA	9	6	1.0
	GIANAKOPI CLO	F 2:17	4.0

# CIF Boys State Championship

Weight Class : **195 Lbs.**



OCHOA, ROBERT (12) CC-2 #16		Gonzales (CC) <b>289</b>		BONILLA	FIL
BONILLA, ADRIAN (12) SS-8		Fillmore (SS)		4	3
BROOKS, ZACH (10) SJ-6		Davis Sr. (SJ) <b>290</b>		REYES #1	GIL
SHEPHERD, TY (10) CS-4		REYES #1		F 3:15	4.0
Frontier (CS) <b>89</b>		F 5:41		4.0	
REYES, RYAN (12) CC-1 #1		LEON, BRANDON (11) SS-4 #8		ROOSEVELT (SS) <b>291</b>	LEON #9
Gilroy (CC)		GARCIA, MASON (11) CS-5		4	2
		Arroyo Grande (CS)		4	2
		DULANTO, LEONARDO (12) SF-1		4	2
		Galileo (SF) <b>292</b>		RASMUSSEN #8	FB
NAUGLE, JUSTIN (12) NC-2		RASMUSSEN #8		F 1:31	4.0
Casa Grande (NC) <b>90</b>		F 4:35		4.0	
RASMUSSEN, ANDREW (12) SS-3 #8		GILMORE, LAITH (11) SD-3 #12		GILMORE #12	POW
Faith Baptist (SS)		Poway (SD) <b>293</b>		6	1
		VALLADARES, JOSEPH (12) LA-1		6	1
		Bell (LA)		6	1
		SAYLES, FREDERICK (12) CS-3		4	2
		Clovis (CS) <b>294</b>		MING #5	EG
HERNANDEZ, RODRIGO (12) SS-6		MING #5		F 3:23	4.0
Capistrano Valley (SS) <b>91</b>		F 3:19		4.0	
MING, PETER (11) SJ-2 #5		GOLDING, CODY (12) SJ-1 #4		Oakdale (SJ) <b>295</b>	GOLDING #4
Elk Grove (SJ)		MENDIVEL, MICHAEL (12) CS-6		DEF	6.0
		Bakersfield (CS)		4	2
		MORGAN, MICHAEL (12) SD-2		4	2
		Eastlake (SD) <b>296</b>		GIPSON	SUT
GIPSON, MAX (11) NS-2		GIPSON		F :44	4.0
Sutter (NS) <b>92</b>		F 1:06		4.0	
ESTRADA, RIGO (11) SS-7 #13		MARTIN, JADON (11) CS-1 #3		Buchanan (CS) <b>297</b>	MARTIN #3
Northview (SS)		RICHARDS, JACK (11) SS-9		F 1:37	6.0
		Royal (SS)		4	2
		LOWE, ADAM (12) SJ-5		4	2
		Del Oro (SJ) <b>298</b>		JACKSON #14	KNG
WILLIAMS, XAVIER (11) NC-3		JACKSON #14		5	2
Livermore (NC) <b>93</b>		11		4	2.0
JACKSON, BO (12) CS-2 #14		GOULD, BEN (12) SS-1 #6		Valencia/Valencia <b>299</b>	GOULD #6
Kingsburg (CS)		VACA, ALEX (12) CS-7		F :53	6.0
		Madera (CS)		4	3
		OLIVER, NOAH (12) OS-1		Oakland Tech (OS) <b>300</b>	THOMAS
THOMAS, PETER (12) SD-4		OAKLAND TECH (OS)		F :18	4.0
Torrey Pines (SD) <b>94</b>		THOMAS		14	0
HOUGHTEN, ELLIOT (12) SJ-3 #11		WILSON, TRISTEN (11) SS-2 #7		Servite (SS) <b>301</b>	WILSON #7
Calaveras (SJ)		CARDENAS, JAVIER (12) CS-8		3	1
		El Diamante (CS)		3	1
		HANSEN, SHANE (11) SD-1		4	3
		Oceanside (SD) <b>302</b>		HANSEN	OCE
GRACIA, JUSTIN (12) CC-3		BISPING #10		CAN	12
Evergreen Valley (CC) <b>95</b>		2		0	2.0
BISPING, CALLUM (12) SS-5 #10		DAHLE, REAGAN (12) NS-1 #15		Big Valley (NS) <b>303</b>	DAHLE #15
Canyon (SS)		TRIPP, JUSTIN (11) CS-9		F 1:57	6.0
		Mt. Whitney (CS)		4	3
		WEST, KADEN (11) SJ-4		Oak Ridge (SJ) <b>304</b>	CHAVEZ #2
UNDERWOOD, CODY (12) CS-T		OAK RIDGE (SJ)		13	12
Clovis North (CS) <b>96</b>		CHAVEZ #2		13	12
CHAVEZ, ADRIAN (12) NC-1 #2		F :39		4.0	2.0
Liberty (NC)					

## 195 Lbs.

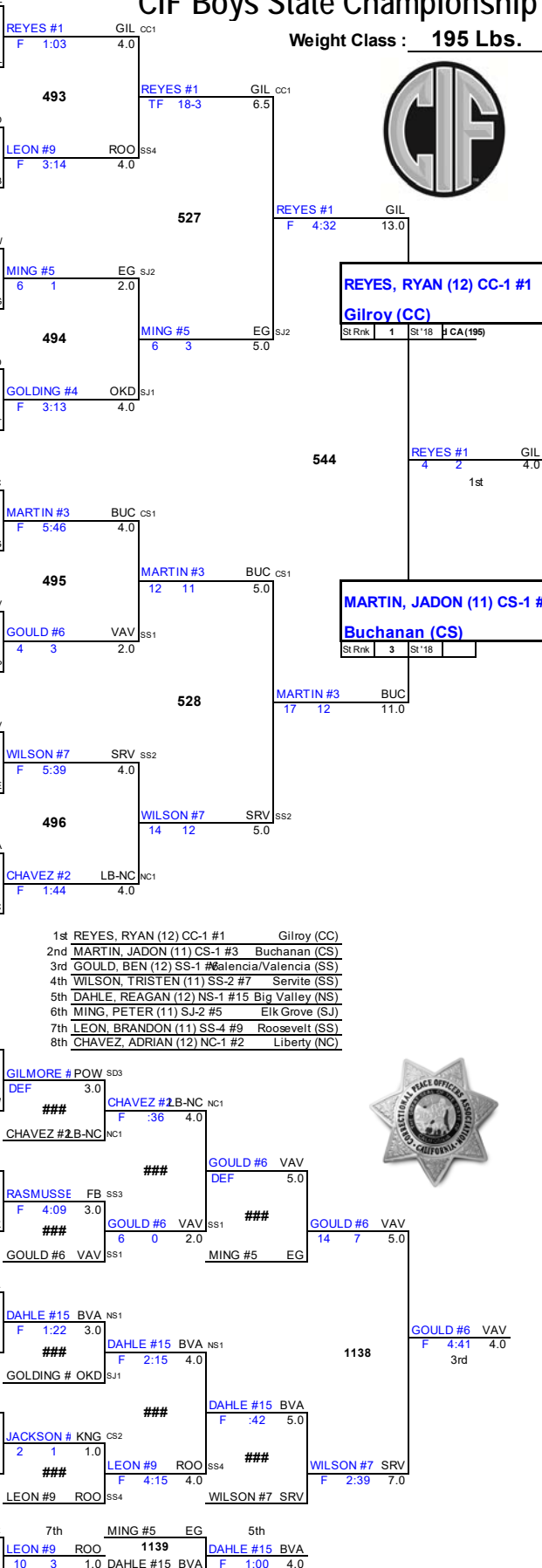

SHEPHERD		FRO		RICHARDS		ROY	
RICHARDS		ROY		F 4:10		3.0	
689		LOWE		DO		F 3:35	
		GIPSON		SUT		7	
NAUGLE		CG		801		913	
VACA		MAD		6		1	
690		OLIVER		OT		F 1:27	
HERNANDEZ		CV		802		GILMORE # POW	
CARDENAS		ELD		5		3	
691		BISPING #10		CAN		4	
ESTRADA #13		NVW		803		RASMUSSE	
TRIPP		MVW		12		6	
692		WEST		OR		F :46	
WILLIAMS		LIV		804		BONILLA	
OCHOA #16		GON		916		OCHOA #16	
693		BROOKS		DAV		F 4:32	
HOUGHTEN #1		CLV		805		DAHLE #15	
GARCIA		AGR		14		3	
694		DULANTO		GAL		F 2:27	
GRACIA		EV		806		HANSEN	
VALLADARES		BL		5		0	
695		SAYLES		CLO		F :58	
UNDERWOOD		CN		807		THOMAS	
MENDIVEL		BAK		DEF		3.0	
696		MORGAN		EAS		F 2:03	
		JACKSON #		KNG		5	
		808		JACKSON #		KNG	
		920					

CHAVEZ #2 B-NC	7th	MING #5	EG	5th
1140	LEON #9	ROO	1139	DAHLE #15
LEON #9	ROO	10	3	1.0
	DAHLE #15	BVA	F 1:00	4.0



# CIF Boys State Championship

Weight Class : **220 Lbs.**



WATSON, KWABENA (12) CS-4 #16		Edison (CS) <b>305</b>		WATSON #16	ED-CS	CS4	4.0
SANCHEZ, SAUL (12) SD-2		West Hills (SD)		<b>433</b>			6.0
TEDDER, TRAVIS (12) NS-2		Sutter (NS)		<b>306</b>	Jaquez #1	BP	4.0
GASKIN, JACOB (12) SS-6		Walnut (SS)		<b>97</b>	Jaquez #1	BP	4.0
Jaquez, Victor (12) CC-1 #1		Bellamine Prep (CC)			F :41	4.0	4.0
DARTER, JUSTIN (10) CS-2 #8		Bakersfield (CS)		<b>307</b>	DARTER #8	BAK	4.0
MELENDEZ, LOGAN (12) SS-8		Temecula Valley (SS)		<b>434</b>			4.0
CHATMAN, ISAAH (12) NC-1		Pittsburg (NC)		<b>308</b>	ISLAND #9	VAC	2.0
PULIS, HAYDEN (11) CS-T		Hanford (CS)		<b>98</b>	ISLAND #9	VAC	2.0
ISLAND, CHRIS (11) SJ-2 #9		Vacaville (SJ)			F 1:27	4.0	4.0
RUIZ, MIKE (12) SS-3 #5		Villa Park (SS)		<b>309</b>	RUIZ #5	VP	5.0
CARDWELL, BRANDEN (12) CS-1		Buchanan (CS)		<b>435</b>			5.0
MILLER, NATHAN (12) SD-3		Vista (SD)		<b>310</b>	BAROLA #12	NVW	4.0
TURCIOS, NOAH (11) LA-1		Granada Hills (LA)		<b>99</b>	BAROLA #12	NVW	4.0
BAROLA, DAVID (12) SS-4 #12		Northview (SS)			F 1:50	4.0	4.0
ESCOBEDO, GUILLERMO (11) SS-1 #4		Bishop Amat (SS)		<b>311</b>	ESCOBEDO #4	BA	6.0
KHAMISY, ELIAS (12) NC-2		Mission San Jose (NC)		<b>436</b>			6.0
DAVALOS, ISAAC (12) SJ-6		Lincoln-S (SJ)		<b>312</b>	MORALES #13	CW	4.0
FERNANDEZ, NATE (10) CC-3		Monte Vista Christian (CC)		<b>100</b>	MORALES #13	CW	4.0
MORALES, MATEO (11) CS-3 #13		Clovis West (CS)			F :42	4.0	4.0
OSTEEN, ERICH (12) SS-2 #3		Chaminade (SS)		<b>313</b>	OSTEEN #3	CHM	6.0
POMILIA, FRANKIE (11) NC-3		Ukiah (NC)		<b>437</b>			6.0
WATSON, TYLER (12) SD-1		Mt Carmel (SD)		<b>314</b>	MORA	PIT	2.0
MORA, JUAN (10) SJ-5		Pitman (SJ)		<b>101</b>	MORA	PIT	2.0
NUNLEY, BEAR (11) CS-5 #14		Tulare Union (CS)			F 4:00	4.0	4.0
CHRISTENSEN, JACOB (10) NS-1 #6		Durham (NS)		<b>315</b>	CHRISTENSEN #6	DUR	4.0
BOUTTE, AUREK (12) SS-7		Palm Springs (SS)		<b>438</b>			4.0
PAFFORD, JACK (12) CS-9		Frontier (CS)		<b>316</b>	MITTLESTEAD	EXT	4.0
MITTLESTEAD, ERIC (12) CS-7		Exeter (CS)		<b>102</b>	MITTLESTEAD	EXT	4.0
COBABE, PRESTON (12) SJ-4 #11		Oak Ridge (SJ)			F 2:14	4.0	4.0
RICHARDS, KYLE (12) SJ-1 #7		Folsom (SJ)		<b>317</b>	RICHARDS #7	FOL	6.0
RODRIGUEZ, EDWIN (12) OS-1		Skyline (OS)		<b>439</b>			6.0
AISPURO, GERARDO (12) CS-8		McFarland (CS)		<b>318</b>	RENTFRO #10	HIL	2.0
LEE, PAUL (12) SS-9		South Torrance (SS)		<b>103</b>	RENTFRO #10	HIL	2.0
RENTFRO, JUSTIN (12) SJ-3 #10		Hilmar (SJ)			3 2	2.0	2.0
CARRANZA, GABRIEL (11) SS-5 #15		Victor Valley (SS)		<b>319</b>	CARRANZA #15	VV	6.0
WILSON, OUT (12) SF-1		KIPP (SF)		<b>440</b>			6.0
JOHNSON, CHAMPION (10) SD-4		The Bishops School (SD)		<b>320</b>	GOOD #2	CLO	4.0
JOHNSEN, DESI (9) CC-2		Gilroy (CC)		<b>104</b>	GOOD #2	CLO	4.0
GOOD, JACOB (12) CS-1 #2		Clovis (CS)			F :40	4.0	4.0

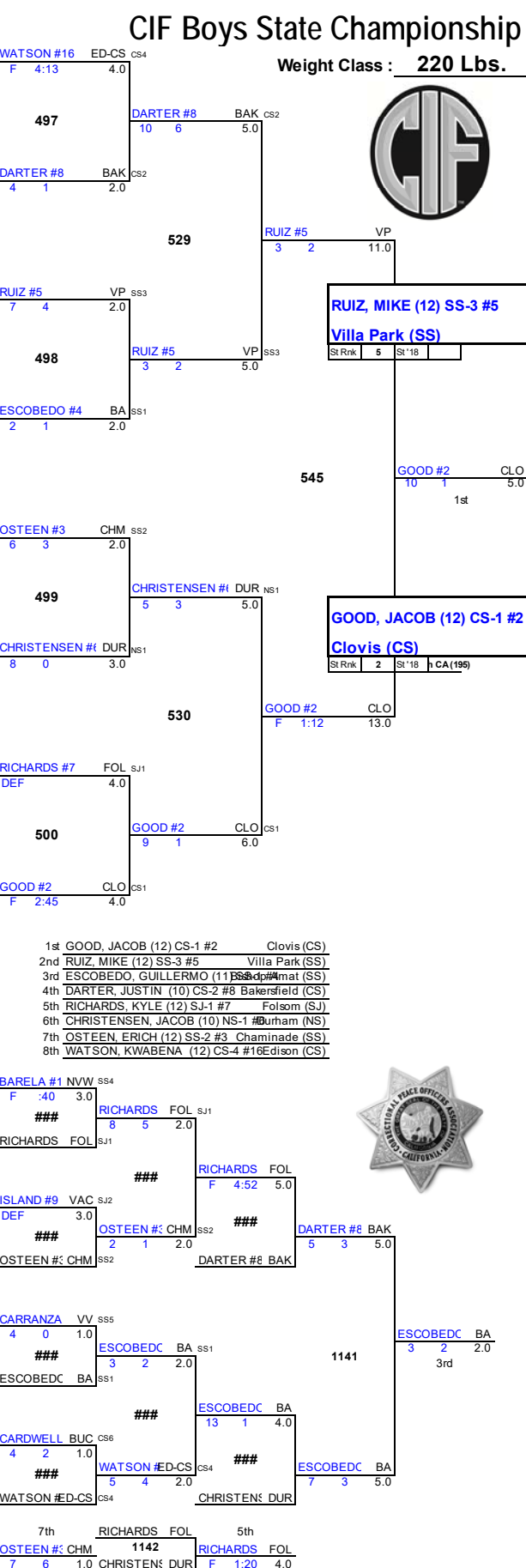

GASKIN	WAL	GASKIN	WAL	WATSON	MCA	MORALES	CW
POMILIA	UKI	1	0	1.0	F 1:45	3.0	
PULIS	HAN	809		MORALES #	CW	F 2:10	3.0
BOUTTE	PS	F 1:54	3.0	PAFFORD	FRO	2	1
BOUTTE	PS	PAFFORD	FRO	2	1	1.0	
TURCIOS	GH	810		BAROLA #12	NVW	F 1:29	3.0
RODRIGUEZ	SKY	F 1:21	3.0	AISPURO	MCF	F :54	3.0
FERNANDEZ	MVC	811		ISLAND #9	VAC	F 2:02	3.0
WILSON	KIP	DEF	3.0	FERNANDEZ	MVC	923	
NUNLEY #14	TU	812		JOHNSON	TBS	F 1:51	3.0
SANCHEZ	WH	3	2	1.0	SANCHEZ	WH	924
COBABE #11	OR	813		TEDDER	SUT	7	2
MELENDEZ	TV	F :52	3.0	CHATMAN	PTS	F :58	3.0
LEE	ST	814		CHATMAN	PTS	F :58	3.0
CARDWELL	BUC	4	2	1.0	CARDWELL	BUC	926
JOHNSEN	GIL	815		MILLER	VIS	F 2:13	3.0
KHAMISY	MSJ	4	3	1.0	KHAMISY	MSJ	927
DAVALOS	LN-S	10	2	2.0	DAVALOS	LN-S	928
		816		MORA	PIT	3	2
							1.0



OSTEEN #3	CHM	7th	RICHARDS	FOL	5th
1143	OSTEEN #3	CHM	1142	RICHARDS	FOL
WATSON #ED-CS	7	6	1.0	CHRISTENSEN	DUR
				F 1:20	4.0

# CIF Boys State Championship

Weight Class : **285 Lbs.**



CASTRO, LUIS (12) SD-2 #16 Olympian (SD) <b>321</b> CASTRO #16 F 4:33 6.0	OLY
PAINE, DALTON (12) SJ-6 St. Mary's (SJ) <b>441</b>	GIL
HOUSTON, TRAVONE (11) CS-5 Hanford (CS) <b>322</b> VILLARREAL #1 GIL 4 1 2.0	VILLARREAL #1
PEREZ, ETHAN (12) SS-7 Sultana (SS) <b>105</b> VILLARREAL #1 F :49 4.0	GIL
VILLARREAL, NICHOLAS (11) CC-1 #1 Gilroy (CC)	VILLARREAL #1
CLAY, NATE (12) SS-2 #8 Santa Margarita (S) <b>323</b> CLAY #9 3 2 4.0	CLAY #9
HAYWARD, ERIC (11) SJ-3 Vacaville (SJ) <b>442</b>	CV
CAMPBELL, KADE (10) CS-9 Clovis (CS) <b>324</b> ARRIAGA #8 CV F 1:57 4.0	ARRIAGA #8
LIGHTNER, JACOB (12) CS-6 Kern Valley (CS) <b>106</b> ARRIAGA #8 F 1:43 4.0	CV
ARRIAGA, RANDY (12) SS-1 #8 Capistrano Valley (SS)	ARRIAGA #8
FELICIANO, COHLE (12) CC-2 #5 Fremont (CC) <b>325</b> FELICIANO #5 FR-CC F :26 6.0	FELICIANO #5
COOK, JOHN (12) CS-4 Madera (CS) <b>443</b>	FR-CC
SMITH, JACOB (12) SS-6 Etiwanda (SS) <b>326</b> SMITH ETI F 1:58 6.0	SMITH
CHEVEZ, LEO (12) LA-1 Sylmar (LA) <b>107</b> WILEY, MICHAEL (12) CC-3 #12 Los Gatos (CC)	ETI
SLATIC, TOMMY (12) CS-3 #13 Bullard (CS) <b>327</b> SLATIC #13 BUL 13 0 5.0	SLATIC #13
PERLA, RICKY (11) SS-5 Los Osos (SS) <b>444</b>	BUL
ALLEN, BEN (12) NS-1 Chico (NS) <b>328</b> SARTORIO CLY F 1:45 4.0	SARTORIO
SARTORIO, JACOB (12) NC-2 Clayton Valley (NC) <b>108</b> SARTORIO CLY F 1:45 4.0	CLY
MARKKEY, LEVI (12) SJ-5 #4 Del Campo (SJ)	CLY
VON GOEBEN, WILLIAM (12) SS-3 #14 Walnut (SS) <b>329</b> VON GOEBEN #14 WAL F 1:07 6.0	VON GOEBEN #14
ROJAS III, FRANCISCO (12) CS-7 Liberty Madera (CS) <b>445</b>	WAL
ROE, BEN (11) NC-1 De La Salle (NC) <b>330</b> RAMOS #3 VDL 6 4 2.0	RAMOS #3
SCHMIDT, BLAKE (12) SD-4 Monte Vista (SD) <b>109</b> RAMOS #3 VDL F 2:51 4.0	VDL
RAMOS, JUSTIN (12) SJ-2 #3 Vista del Lago (SJ)	VDL
SCHMIDTKE, JONAH (11) CS-2 #11 Clovis East (CS) <b>331</b> SCHMIDTKE #11 CE F 5:41 6.0	SCHMIDTKE #11
TROMBLEY, KYLE (12) SS-9 Yorba Linda (SS) <b>446</b>	CE
CARRILLO, JOE (12) NS-2 Anderson (NS) <b>332</b> JOHNSON #6 POW F 1:33 4.0	JOHNSON #6
HERRERA, CHRISTIAN (12) CS-T Mission Oak (CS) <b>110</b> JOHNSON, ANDREW (11) SD-1 #6 Poway (SD)	POW
HILL, JOSIAH (11) CS-1 #7 Bakersfield (CS) <b>333</b> HILL #7 BAK 12 0 5.0	HILL #7
TOTEN, MICHAEL (12) SD-3 Holtville (SD) <b>447</b>	BAK
ALANIS, JOSEPH (11) SF-1 Washington (SF) <b>334</b> ERICKSON #10 CRT F :38 4.0	ERICKSON #10
COOK, LUCAS (11) SJ-4 Lincoln-L (SJ) <b>111</b> ERICKSON, ETHEN (12) SS-8 #10 Carter (SS)	CRT
JEFFUS, MICHAEL (12) SJ-1 #2 Turlock (SJ) <b>335</b> JEFFUS #2 TUR F 1:44 6.0	JEFFUS #2
WORD, WYATT (12) NC-3 Liberty (NC) <b>448</b>	TUR
LEE, REGAN (12) CS-8 Golden West (CS) <b>336</b> LEE GW 3 1 2.0	LEE
LOPEZ, DANIEL (12) LA-2 Granada Hills (LA) <b>112</b> AVILA, JOSHUA (12) SS-4 #15 Rowland (SS)	GW
AVILA #15 F 5:30 4.0	ROW

VILLARREAL #1 F 2:31 4.0	GIL CC1
501	VILLARREAL #1
ARRIAGA #8 2 1 2.0	CV SS1
531	VILLARREAL #1
FELICIANO #5 F 2:56 4.0	FR-CC CC2
502	FELICIANO #5
SARTORIO 4 1 2.0	CLY NC2
546	JEFFUS #2
RAMOS #3 9 4 2.0	VDL SJ2
503	RAMOS #3
JOHNSON #6 2 1 2.0	POW SD1
532	JEFFUS #2
HILL #7 F 1:11 4.0	BAK CS1
504	JEFFUS #2
JEFFUS #2 8 4 2.0	TUR SJ1

VILLARREAL, NICHOLAS (11) CC-1 #1 Gilroy (CC)	GIL CC1
3 0 5.0	VILLARREAL #1
11 0 12.0	VILLARREAL #1
JEFFUS #2 3 2 4.0	TUR
1st	
JEFFUS, MICHAEL (12) SJ-1 #2 Turlock (SJ)	TUR
5 2 11.0	JEFFUS #2
1st JEFFUS, MICHAEL (12) SJ-1 #2 Turlock (SJ)	TUR
2nd VILLARREAL, NICHOLAS (11) CC-1 #1 Gilroy (CC)	GIL
3rd RAMOS, JUSTIN (12) SJ-2 #3 Vista del Lago (SJ)	SJ2
4th MARKEY, LEVI (12) SJ-5 #4 Del Campo (SJ)	SJ5
5th FELICIANO, COHLE (12) CC-2 #5 Fremont (CC)	CC2
6th VON GOEBEN, WILLIAM (12) SS-3 #14 Walnut (SS)	SS3
7th HILL, JOSIAH (11) CS-1 #7 Bakersfield (CS)	CS1
8th SARTORIO, JACOB (12) NC-2 Clayton Valley (NC)	NC2

PEREZ, ETHAN (12) SS-7 Sultana (SS) <b>105</b> VILLARREAL #1 F :49 4.0	SUL
VILLARREAL, NICHOLAS (11) CC-1 #1 Gilroy (CC)	SUL
ROJAS III, FRANCISCO (12) CS-7 Liberty Madera (CS) <b>445</b>	SUL
ROE, BEN (11) NC-1 De La Salle (NC) <b>330</b> RAMOS #3 VDL 6 4 2.0	SUL
SCHMIDT, BLAKE (12) SD-4 Monte Vista (SD) <b>109</b> RAMOS #3 VDL F 2:51 4.0	SUL
RAMOS, JUSTIN (12) SJ-2 #3 Vista del Lago (SJ)	SUL
SCHMIDTKE, JONAH (11) CS-2 #11 Clovis East (CS) <b>331</b> SCHMIDTKE #11 CE F 5:41 6.0	SUL
TROMBLEY, KYLE (12) SS-9 Yorba Linda (SS) <b>446</b>	SUL
CARRILLO, JOE (12) NS-2 Anderson (NS) <b>332</b> JOHNSON #6 POW F 1:33 4.0	SUL
HERRERA, CHRISTIAN (12) CS-T Mission Oak (CS) <b>110</b> JOHNSON, ANDREW (11) SD-1 #6 Poway (SD)	SUL
HILL, JOSIAH (11) CS-1 #7 Bakersfield (CS) <b>333</b> HILL #7 BAK 12 0 5.0	SUL
TOTEN, MICHAEL (12) SD-3 Holtville (SD) <b>447</b>	SUL
ALANIS, JOSEPH (11) SF-1 Washington (SF) <b>334</b> ERICKSON #10 CRT F :38 4.0	SUL
COOK, LUCAS (11) SJ-4 Lincoln-L (SJ) <b>111</b> ERICKSON, ETHEN (12) SS-8 #10 Carter (SS)	SUL
JEFFUS, MICHAEL (12) SJ-1 #2 Turlock (SJ) <b>335</b> JEFFUS #2 TUR F 1:44 6.0	SUL
WORD, WYATT (12) NC-3 Liberty (NC) <b>448</b>	SUL
LEE, REGAN (12) CS-8 Golden West (CS) <b>336</b> LEE GW 3 1 2.0	SUL
LOPEZ, DANIEL (12) LA-2 Granada Hills (LA) <b>112</b> AVILA, JOSHUA (12) SS-4 #15 Rowland (SS)	SUL
AVILA #15 F 5:30 4.0	SUL

SLATIC, TOMMY (12) CS-3 #13 Bullard (CS) <b>327</b> SLATIC #13 BUL 13 0 5.0	BUL
PERLA, RICKY (11) SS-5 Los Osos (SS) <b>444</b>	BUL
ALLEN, BEN (12) NS-1 Chico (NS) <b>328</b> SARTORIO CLY F 1:45 4.0	SARTORIO
SARTORIO, JACOB (12) NC-2 Clayton Valley (NC) <b>108</b> SARTORIO CLY F 1:45 4.0	CLY
VON GOEBEN, WILLIAM (12) SS-3 #14 Walnut (SS) <b>329</b> VON GOEBEN #14 WAL F 1:07 6.0	VON GOEBEN #14
ROJAS III, FRANCISCO (12) CS-7 Liberty Madera (CS) <b>445</b>	WAL
RAMOS, JUSTIN (12) SJ-2 #3 Vista del Lago (SJ)	VDL
SCHMIDTKE, JONAH (11) CS-2 #11 Clovis East (CS) <b>331</b> SCHMIDTKE #11 CE F 5:41 6.0	SCHMIDTKE #11
TROMBLEY, KYLE (12) SS-9 Yorba Linda (SS) <b>446</b>	CE
CARRILLO, JOE (12) NS-2 Anderson (NS) <b>332</b> JOHNSON #6 POW F 1:33 4.0	JOHNSON #6
HERRERA, CHRISTIAN (12) CS-T Mission Oak (CS) <b>110</b> JOHNSON, ANDREW (11) SD-1 #6 Poway (SD)	POW
HILL, JOSIAH (11) CS-1 #7 Bakersfield (CS) <b>333</b> HILL #7 BAK 12 0 5.0	HILL #7
TOTEN, MICHAEL (12) SD-3 Holtville (SD) <b>447</b>	BAK
ALANIS, JOSEPH (11) SF-1 Washington (SF) <b>334</b> ERICKSON #10 CRT F :38 4.0	ERICKSON #10
COOK, LUCAS (11) SJ-4 Lincoln-L (SJ) <b>111</b> ERICKSON, ETHEN (12) SS-8 #10 Carter (SS)	CRT
JEFFUS, MICHAEL (12) SJ-1 #2 Turlock (SJ) <b>335</b> JEFFUS #2 TUR F 1:44 6.0	JEFFUS #2
WORD, WYATT (12) NC-3 Liberty (NC) <b>448</b>	TUR
LEE, REGAN (12) CS-8 Golden West (CS) <b>336</b> LEE GW 3 1 2.0	LEE
LOPEZ, DANIEL (12) LA-2 Granada Hills (LA) <b>112</b> AVILA, JOSHUA (12) SS-4 #15 Rowland (SS)	GW
AVILA #15 F 5:30 4.0	ROW



HILL #7 1146 SARTORIO CLY	7th F :51 3.0	FELICIANO FR-CC 1145 VON GOEB WAL	5th F 7 4 2.0
---------------------------------	---------------------	---	------------------------